

# **MELSEC System Q**

Programmable Logic Controllers

Users's Manual

## **QJ71PB92D**

### **Profibus/DP Master**



## • SAFETY PRECAUTIONS •

(Read these precautions before using.)

Before using this product, please read this manual and the relevant manuals introduced in this manual carefully and pay full attention to safety to handle the product correctly.

The instructions given in this manual are concerned with this product. For the safety instructions of the programmable controller system, please read the user's manual of the CPU module used.

In this manual, the safety instructions are ranked as "DANGER" and "CAUTION".



Indicates that incorrect handling may cause hazardous conditions, resulting in death or severe injury.



Indicates that incorrect handling may cause hazardous conditions, resulting in medium or slight personal injury or physical damage.

Note that the  CAUTION level may lead to a serious consequence according to the circumstances. Always follow the instructions of both levels because they are important to personal safety.

Please save this manual to make it accessible when required and always forward it to the end user.

### [DESIGN PRECAUTIONS]

#### DANGER

- When a communication error occurs in the PROFIBUS-DP, the status of the faulty station is as follows. Configure an interlock circuit in the sequence program using the communication status information (input X1, buffer memory 2040 (7F8<sub>H</sub>) to 2079 (81F<sub>H</sub>)) so that the system can operate safely.  
Erroneous outputs and mis-operation could cause accidents.
  - (1) The input data of the master station maintains the data before abnormality of the communication.
  - (2) When the master station is down, the output state of each slave station will be in accordance with the parameter settings.
  - (3) When any slave station is down, the output state of other slave stations will be in accordance with the parameter settings of the master station.
- Do not output the "prohibited to use" signal as the output signal to an intelligent function module from the programmable controller CPU.  
Writing data into the "system area" or outputting a signal for "prohibited to use" may cause system malfunction in the programmable controller.

## [DESIGN PRECAUTIONS]

### DANGER

- When a stop error has occurred to the CPU module, the communication status varies depending on the intelligent function module switch setting of GX Developer as shown below. Set the communication status for when a stop error has occurred to the CPU module according to the system specifications.
  - (1) When no setting (blank) is made to the switch 1 of the intelligent function module switch setting
    - (a) Since the communication with the slave station is continued, values at the time of the CPU module stop error occurrence are held as the output data sent to the slave station from the QJ71PB92D.
    - (b) Input data received from slave stations are updated into the buffer memory of the QJ71PB92D.
  - (2) When 0001<sub>H</sub> is set to the switch 1 of the intelligent function module switch setting
    - (a) Communications with slave stations are interrupted, and output data are not sent.
    - (b) Input data received from slave stations are held in the buffer memory of the QJ71PB92D.

### CAUTION

- When the PROFIBUS cable is laid, do not lay it close to main circuits or power lines. They should be installed 100mm(3.9inch) or more from each other. Not doing so could result in noise that would cause malfunctioning.

## [INSTALLATION PRECAUTIONS]

### CAUTION

- Use the programmable controller in an environment that meets the general specifications contained in the CPU user's manual.  
Using this programmable controller in an environment outside the range of the general specifications may cause electric shock, fire, malfunction, and damage to or deterioration of the product.
- While pressing the installation lever located at the bottom of module, insert the module fixing tab into the fixing hole in the base unit until it stops.  
Then, securely mount the module with the fixing hole as a supporting point.  
If the module is not installed properly, it may cause the module to malfunction, fail or fall off.  
Secure the module with screws especially when it is used in an environment where constant vibrations or strong impact may be expected.

## [INSTALLATION PRECAUTIONS]

### CAUTION

- Tighten the screws within the range of specified torque.  
If the screws are loose, it may cause the module to fallout, short circuits, or malfunction.  
If the screws are tightened too much, it may cause damage to the screw and/or the module, resulting in fallout, short circuits or malfunction.
- Be sure to shut off all phases of the external power supply used by the system before mounting or removing the module.  
Not doing so may cause electric shock or damage to the module.
- Do not touch the conductive area or electric parts of the module.  
Doing so may cause module malfunctioning or breakdowns.

## [WIRING PRECAUTIONS]

### CAUTION

- Be sure to shut off all phases of the external power supply used by the system before wiring PROFIBUS cables. If you not switch off the external power supply, it will cause failure or malfunction of the module.
- Be careful not to let foreign matter such as filings or wire chips get inside the module. These can cause fire, breakdowns and malfunctioning.
- Be sure to place the PROFIBUS cables in a duct or clamp them.  
If not, dangling cables may be shifted or inadvertently pulled, resulting in damages to the module or cables or malfunctions due to poor cable contact.
- When disconnecting the PROFIBUS cable from the module, do not pull by holding the cable section. To disconnect the cable, make sure to hold the connector which is coupled with the module. Do not attempt to pull the cable to disconnect it from the module. It could damage the module or the cable, or cause malfunction due to a poor contact of the cable.
- A protective film is attached onto the module top to prevent foreign matter such as wire chips from entering the module when wiring.  
Do not remove the film during wiring.  
Remove it for heat dissipation before system operation.

## [STARTING AND MAINTENANCE PRECAUTIONS]

### DANGER

- Before cleaning, be sure to shut off all phases of the external power supply used by the system. Not doing so could cause electric shock.

## [STARTING AND MAINTENANCE PRECAUTIONS]

### CAUTION

- Never disassemble or modify the module.  
This may cause breakdowns, malfunctioning, injury and/or fire.
- When using a wireless communication device such as a cellular phone, keep a distance of 25cm (9.85 inch) or more from the programmable controller in all directions.  
Failure to do so can cause a malfunction.
- Be sure to shut off all phases of the external power supply before mounting or removing the module. If you do not switch off the external power supply, it will cause breakdowns or malfunction of the module.
- Set the ON/OFF select switch of the terminal resistor before the operation.  
If the setting is switched during the operation, network error may occur, or error detection may not be performed by error.
- Do not mount/remove the module onto/from the base unit more than 50 times (IEC61131-2-compliant), after the first use of the product.  
Failure to do so may cause the module to malfunction due to poor contact of connector.
- Before handling the module, always touch grounded metal, etc. to discharge static electricity from the human body.  
Failure to do so can cause the module to fail or malfunction.

## [DISPOSAL PRECAUTIONS]

### CAUTION

- When disposing of this product, treat it as industrial waste.

REVISIONS

\* The manual number is given on the bottom left of the back cover.

Print Date	* Manual Number	Revision
Dec., 2000	SH (NA)-080127-A	First edition
May, 2001	SH (NA)-080127-B	<p><b>Corrections</b>                      About the Generic Terms and Abbreviations, Section 2.1, 2.4, 4.1.3, 4.1.4, 5.1, 5.1.1, 5.4, 8.1, 8.2</p>
Apr., 2004	SH (NA)-080127-C	<p><b>Corrections</b>                      Section 1.2, 2.1, 2.4, 3.1, 3.2.3, 3.3.2, 3.4.2, 4.1.4, 5.1, 5.1.1, 5.2.1, 5.3, 5.5.3, 6.1, 6.2, Chapter 7, Section 7.1, Chapter 9, Appendix 1, Appendix 3</p> <p><b>Additions</b>                      SAFETY PRECAUTIONS, About Manuals, Conformation to the EMC Directive and Low Voltage Instruction, Section 7.1, Chapter 9</p>
Aug., 2004	SH (NA)-080127-D	<p><b>Corrections</b>                      SAFETY PRECAUTIONS, Section 3.2.2, 3.2.3, 3.4.2, 5.1.1, 5.5.1, Chapter 7</p>
Jul., 2006	SH (NA)-080127-E	The entire manual was reviewed.
May, 2007	SH (NA)-080127-F	<ul style="list-style-type: none"> <li>• Rewritten to include the QJ71PB92D-compatible function.</li> <li>• Modified for descriptions of GX Configurator-DP Version 7.02C.</li> </ul> <p><b>Corrections</b>                      SAFETY PRECAUTIONS, About Manuals, About the Generic Terms and Abbreviations, Meanings and Definitions of Terms, Chapter 1, Section 1.1, 2.1, 2.4, 3.1, 3.2.1, 4.1.4, 5.1, 5.1.2 to 5.1.5, 5.3 to 5.5.2, 7.1.2, 7.1.4 to 7.5, 8.1 to 8.3, Chapter 9, Section 9.1</p> <p><b>Additions</b>                      Section 4.3, 5.1.6, 7.1.1, 9.2 to 9.4.2, Appendix 1</p> <p><b>Section number changes</b>                      Section 7.1(1)(a) to (b) → Section 7.1.2 to 7.1.3                      Section 7.1(2) → Section 7.1.4                      Section 7.2 to 7.3 → Section 7.3 to 7.4                      Section 7.4 → Section 7.2                      Chapter 9 → Section 9.1                      Section 9.1 → Section 9.5                      Appendix 1 to 3 → Appendix 2 to 4</p>

Japanese Manual Version SH-080126-F

This manual confers no industrial property rights or any rights of any other kind, nor does it confer any patent licenses. Mitsubishi Electric Corporation cannot be held responsible for any problems involving industrial property rights which may occur as a result of using the contents noted in this manual.

© 2000 MITSUBISHI ELECTRIC CORPORATION

## INTRODUCTION

Thank you for purchasing the Mitsubishi Programmable Controller MELSEC-Q Series.  
Before using the equipment, please read this manual carefully to develop full familiarity with the functions and performance of the graphic operation terminal you have purchased, so as to ensure correct use.  
Please forward a copy of this manual to the end user.

## CONTENTS

SAFETY PRECAUTIONS .....	A - 1
REVISIONS.....	A - 5
INTRODUCTION.....	A - 6
CONTENTS .....	A - 6
About Manuals .....	A - 9
Conformation to the EMC Directive and Low Voltage Instruction.....	A - 9
About the Generic Terms and Abbreviations.....	A -10
Meanings and Definitions of Terms .....	A -11
Product Structure .....	A -12
<b>1. OVERVIEW</b> .....	<b>1- 1 to 1- 4</b>
1.1 QJ71PB92D Features.....	1- 3
<b>2. SYSTEM CONFIGURATION</b> .....	<b>2- 1 to 2- 6</b>
2.1 Applicable System .....	2- 1
2.2 When Used in Multiple CPU System .....	2- 4
2.3 Precautions for Configuring a System .....	2- 4
2.4 Checking the Function Version and Serial No.....	2- 5
<b>3. SPECIFICATIONS</b> .....	<b>3- 1 to 3- 50</b>
3.1 Performance Specifications .....	3- 1
3.2 Network Configuration .....	3- 3
3.2.1 Basic configuration .....	3- 3
3.2.2 Applicable configuration .....	3- 5
3.2.3 Number of connectable slaves .....	3- 9
3.3 I/O Signal .....	3-12
3.3.1 I/O signal list .....	3-12
3.3.2 I/O signal detail description .....	3-13
3.4 Buffer Memory List.....	3-22
3.4.1 Buffer memory/configuration .....	3-22
3.4.2 Buffer memory detailed description.....	3-23
<b>4. FUNCTIONS</b> .....	<b>4- 1 to 4- 18</b>
4.1 Functions for Exchanging with Slaves .....	4- 1
4.1.1 I/O data exchange .....	4- 1
4.1.2 Global control functions.....	4- 3
4.1.3 Word data swap function.....	4- 7
4.1.4 I/O data separation prevention function .....	4-10
A - 6 .....	A - 6



4.2 Operation Mode .....	4-13
4.2.1 Normal service mode (MODE 0) .....	4-15
4.2.2 Extended service mode (MODE E) .....	4-16
4.3 Output Status Setting for the Case of a CPU Stop Error.....	4-17

<b>5. PROCEDURES BEFORE SYSTEM OPERATION</b>	<b>5- 1 to 5- 34</b>
--	----------------------

5.1 Procedures before Operation.....	5- 1
5.1.1 Parameter setting procedure.....	5- 6
5.1.2 Master parameters .....	5- 7
5.1.3 Bus parameters.....	5-10
5.1.4 Slave parameters .....	5-12
5.1.5 Automatic refresh parameters.....	5-15
5.1.6 Intelligent function module switch setting.....	5-23
5.2 Installation.....	5-25
5.2.1 Handling precautions.....	5-25
5.2.2 Installation environment .....	5-25
5.3 Part Names and Settings .....	5-26
5.4 Execution Method for Self-diagnosis .....	5-28
5.5 Wiring.....	5-30
5.5.1 PROFIBUS cable wiring.....	5-30
5.5.2 Terminator .....	5-32
5.5.3 Precautions against wiring .....	5-33
5.6 Maintenance and Inspection .....	5-34

<b>6. COMMUNICATION TIME</b>	<b>6- 1 to 6- 5</b>
------------------------------	---------------------

6.1 Bus Cycle Time.....	6- 1
6.2 Transmission Delay Time .....	6- 5

<b>7. PROGRAMMING</b>	<b>7- 1 to 7- 23</b>
-----------------------	----------------------

7.1 Communication Using Automatic Refresh Setting.....	7- 4
7.1.1 When using GX Configurator-DP Version 7.01B or later .....	7- 4
7.1.2 When using GX Configurator-DP Version 5 to 7.00A .....	7- 7
7.1.3 When using GX Configurator-DP Version 4.....	7- 9
7.1.4 Program example .....	7-15
7.2 Communication Using Dedicated Instruction.....	7-17
7.3 Normal Service Mode (MODE 0) Using MOV Instruction.....	7-19
7.4 Extended Service Mode (MODE E) Using MOV Instruction.....	7-21
7.5 Execution of Global Control .....	7-23

<b>8. DEDICATED INSTRUCTIONS</b>	<b>8- 1 to 8- 4</b>
----------------------------------	---------------------

8.1 Dedicated Instruction List and Available Devices.....	8- 1
8.2 G.BBLKRD .....	8- 3
8.3 G.BBLKWR .....	8- 4

9. TROUBLESHOOTING	9- 1 to 9- 20
--------------------	---------------

9.1 Error Check Using the LEDs and Corrective Actions .....	9- 2
9.2 When Parameters cannot be Written from GX Configurator-DP .....	9- 4
9.3 When Communication with Slave Stations is Not Possible .....	9- 6
9.4 Error Code.....	9-10
9.4.1 Error codes for the QJ71PB92D.....	9-12
9.4.2 Error codes for the QJ71PB92V (QJ71PB92D-compatible function).....	9-15
9.5 Initialization of Flash ROM When Parameters are Corrupted .....	9-18

APPENDICES	App - 1 to App - 8
------------	--------------------

Appendix 1 Replacement with the QJ71PB92V (QJ71PB92D-compatible function) .....	App - 1
Appendix 1.1 Precautions for replacing the QJ71PB92D with the QJ71PB92V .....	App - 2
Appendix 2 Differences between QJ71PB92D and A1SJ71PB92D/AJ71PB92D .....	App - 4
Appendix 3 Extended Trouble Information of Mitsubishi's Slaves .....	App - 5
Appendix 4 External Dimensions .....	App - 6

INDEX	Index 1 to Index - 2
-------	----------------------

## About Manuals

The following are manuals related to this product.

Please purchase them if necessary.

### Related Manuals

Manual Name	Manual Number
GX Configurator-DP Version 7 Operating Manual Explains the overview, installation method, screen operations, etc. of GX Configurator-DP Version 7. (Sold separately)	SH-080579ENG (13JU54)
PROFIBUS-DP Master Module User's Manual Explains the overview, system configuration, specifications, functions, procedures before system operation, programming and dedicated instructions of QJ71PB92V. (Sold separately)	SH-080572ENG (13JR84)

\* Inquiries can be made to :  
MITSUBISHI ELECTRIC EUROPE Factory Automation  
Gothaer Strasse 8 D-40880 Ratingen Germany  
Phone : +49(21 02)486-0  
Fax : +49(21 02)486-717

### Conformation to the EMC Directive and Low Voltage Instruction

When incorporating the Mitsubishi programmable controller into other machinery or equipment and keeping compliance with the EMC and low voltage directives, refer to Chapter 3 "EMC Directive and Low Voltage Instruction" of the User's Manual (hardware) supplied with your CPU module or base unit.

The CE logo is printed on the rating plate of the programmable controller, indicating compliance with the directives.

Note that no additional measures are necessary for this product to make compliance with the directives.

## About the Generic Terms and Abbreviations

Unless otherwise specified, this manual uses the following generic terms and abbreviations to describe the Type QJ71PB92D PROFIBUS-DP interface module.

Generic Term/Abbreviation	Description of the abbreviation/general terms
QJ71PB92D	Abbreviation for the QJ71PB92D PROFIBUS-DP interface module.
QJ71PB92V	Abbreviation for the QJ71PB92V PROFIBUS-DP master module.
QJ71PB92V (QJ71PB92D-compatible function)	Generic term representing the QJ71PB92V that is operating with the QJ71PB92D-compatible function.
QCPU CPU module	Generic term for Q00JCPU, Q00CPU, Q01CPU, Q02CPU, Q02HCPU, Q06HCPU, Q12HCPU, Q25HCPU, Q12PHCPU, Q25PHCPU, Q03UDCPU, Q04UDHCPU and Q06UDHCPU modules.
GX Developer	Generic product name for SWnD5C-GPPW-E, SWnD5C-GPPW-EA, SWnD5C-GPPW-EV, and SWnD5C-GPPW-EVA. ("n" means version 4 or later.) "-A" and "-V" mean "volume license product" and "version-upgrade product" respectively.
GX Configurator-DP	Configuration tool for QJ71PB92D. Generic term of the product model SWnD5C-PROFID-E. ("n" means version 4 or later.)
PROFIBUS-DP	Abbreviation of PROFIBUS-DP network.
BBLKRD	Abbreviation for G. BBLKRD.
BBLKWR	Abbreviation for G. BBLKWR.

## Meanings and Definitions of Terms

The following explains the meanings and definitions of the terms used in this manual.

Term	Description
PROFIBUS-DPV0	A basic version of PROFIBUS-DP. The following functions are executable: <ul style="list-style-type: none"> <li>• I/O data exchange</li> <li>• Trouble information notification</li> </ul> etc.
PROFIBUS-DPV1	A PROFIBUS-DP version for which the following functions have been added to the basic functionality of PROFIBUS-DPV0. <ul style="list-style-type: none"> <li>• Acyclic communication</li> <li>• Alarm function</li> </ul> etc.
PROFIBUS-DPV2	A PROFIBUS-DP version for which the following functions have been added to the PROFIBUS-DPV1 functionality. <ul style="list-style-type: none"> <li>• Time stamping</li> </ul> etc.
Class 1 master station	A device exchanging I/O data with a slave stations. (QJ71PB92V, QJ71PB92D, etc)
Class 2 master station	A device that communicates with slave stations and checks their FDL address settings and/or operation states. The class 2 master station is used as a master station for supervising the network, which can start, maintain, and diagnose the system.
Slave station	A device that exchanges I/O data with a class 1 master station. (QJ71PB93D, ST1H-PB, etc)
Repeater	A device used to connect different segments of PROFIBUS-DP.
Bus terminator	A terminating resistor that is connected to either end of each segment on PROFIBUS-DP.
Configuration tool	Software used to set bus parameters, slave parameters, etc. and to write them to a master station. (GX Configurator-DP, etc.)
GSD file	An electronic file that contains parameters of a slave station. The GSD file is used to set up the slave parameters on GX Configurator-DP.
Station number	The numbers assigned to a master station and slave station. The station number is set within the range from 0 to 125.
Bus parameter	The parameter used for the communication setting of PROFIBUS-DP. The bus parameter is set up on the GX Configurator-DP.
Master parameter	The parameter used for the settings (FDL address, transmission speed, etc.) of the QJ71PB92D. The master parameter is set up on the GX Configurator-DP.
Slave parameter	The parameter for a slave station, which is set on the master station. The slave parameter is set up on the GX Configurator-DP. The setting items are described on the GSD File.
I/O CONFIGURATION DATA	Information on I/O configuration of a slave station.
I/O data exchange	This function allows I/O data exchange between a class 1 master station and slave stations.
Global control	This function enables synchronization command transmission for I/O data from a class 1 master station to slave station.
Trouble information	Trouble information of PROFIBUS-DP, which is detected by a master station or notified by a slave station.
Expansion communication trouble information	Trouble information specific to each slave station. Each of slave stations notifies of it to the master station when an error is detected.
Bus cycle time	PROFIBUS-DP processing time for the master station to perform cyclic transfer with each slave station.
QJ71PB92D-compatible function	The function used to replace the QJ71PB92D with the QJ71PB92V. The model QJ71PB92V, PROFIBUS-DP master module has this function.

Product Structure

The product structure of this product is given in the table below.

Model	Product Name	Quantity
QJ71PB92D	QJ71PB92D PROFIBUS-DP interface module	1

1. OVERVIEW

This user's manual describes the following modules:

- The model QJ71PB92D, PROFIBUS-DP interface module (QJ71PB92D)
- The model QJ71PB92V, PROFIBUS-DP master module, which is operating with the QJ71PB92D-compatible function (QJ71PB92V (QJ71PB92D-compatible function))

When explain separately, which is used to connect a MELSEC-Q series programmable controller to a PROFIBUS-DP network.

The QJ71PB92D operates as a class 1 master station in the PROFIBUS-DP network.

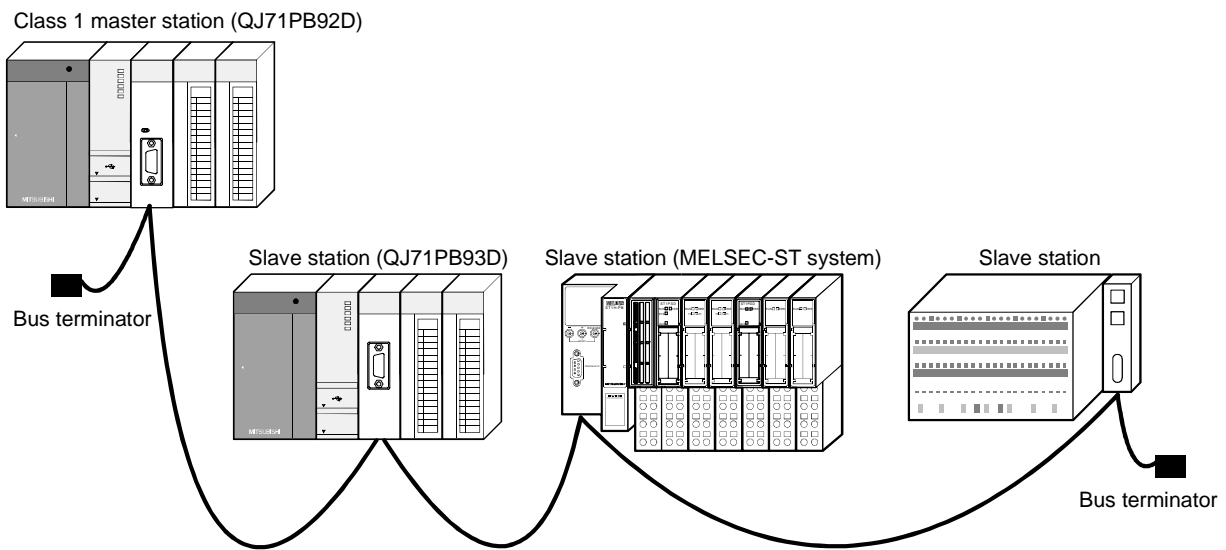

(1) Distinctions between the QJ71PB92D and the QJ71PB92V (QJ71PB92D-compatible function)

Operations of the QJ71PB92D and QJ71PB92V (QJ71PB92D-compatible function) are described as follows:

- (a) Operations that are common to the QJ71PB92D and the QJ71PB92V (QJ71PB92D-compatible function)

Described as the QJ71PB92D.

- (b) Operations that are different between the QJ71PB92D and the QJ71PB92V (QJ71PB92D-compatible function)

Explained separately, using the following icons.

**QJ71PB92D** : Operations of the QJ71PB92D

**QJ71PB92V (92D-compatible)** : Operations of the QJ71PB92V (QJ71PB92D-compatible function)

**POINT**  
When replacing the QJ71PB92D with the QJ71PB92V, refer to Appendix 1.

**REMARK**

The QJ71PB92D-compatible function is provided for replacing the QJ71PB92D with the QJ71PB92V.

When the QJ71PB92D has failed, replace it with the QJ71PB92V using the QJ71PB92D-compatible function.

Since the existing network configuration or sequence programs for the QJ71PB92D can be utilized, a faulty QJ71PB92D can be smoothly replaced with the QJ71PB92V.

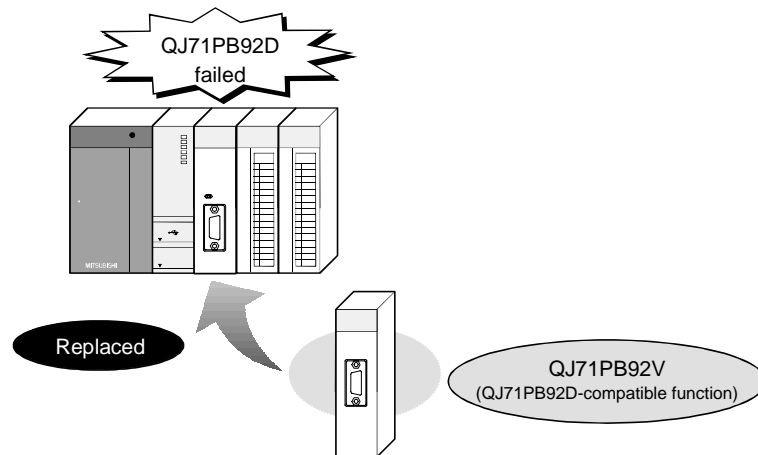



## 1.1 QJ71PB92D Features

## (1) Class 1 master station on PROFIBUS-DP

The QJ71PB92D complies with EN50170, and operates as a class 1 master station on PROFIBUS-DP systems.

The QJ71PB92D supports the PROFIBUS-DPV0 function.

PROFIBUS-DPV1 and PROFIBUS-DPV2, which are extended versions of PROFIBUS-DP, are not supported.

## (a) Up to 60 slave stations are connectable

Up to 60 slave stations can be connected to a single QJ71PB92D, enabling the I/O data exchange of max. 3840 bytes. (Input data: max.1920 bytes, Output data: max.1920 bytes) (Refer to Section 4.1.1)

## (b) Trouble information can be easily acquired

Trouble or extended trouble information of an error occurred on a slave station during I/O data exchange can be easily acquired using the buffer memory and I/O signals. (Refer to Section 3.3, 3.4)

## (c) Supporting the global control function

By sending services (SYNC, UNSYNC, FREEZE, UNFREEZE) to each slave station in a group, synchronous control of slave station I/O data is available. (Refer to Section 4.1.2)

Service Name	Description
SYNC	This service is for synchronizing the output status of slave stations. In the SYNC mode, the output status of a slave station is refreshed each time it receives the SYNC service. While no SYNC service is received, the output status is held.
UNSYNC	This service is for ending the SYNC mode.
FREEZE	This service is for synchronizing the input status of slave stations. In the FREEZE mode, the input status of a slave station is refreshed each time it receives the FREEZE service. While no FREEZE service is received, the input status is held.
UNFREEZE	This service is for ending the FREEZE service.

## (2) I/O data separation prevention

Using the automatic refresh setting in GX Configurator-DP or dedicated instructions (BBLKRD/BBLKWR) ensures data separation prevention when reading/writing I/O data from the QJ71PB92D buffer memory. (Refer to Section 4.1.4)

## (3) Easy parameter setup

Use of GX Configurator-DP enables bus parameters, master parameters, slave parameters, and various other parameters to be easily set up. (Refer to Section 5.1.1 to 5.1.5)

- (4) **Swapping of I/O data**  
The upper and lower bytes can be reversed (swapped) in word units when I/O data is sent or received. (Refer to Section 4.1.3)  
This simplifies programming as you no longer need to create a program for swapping the upper and lower bytes on the QJ71PB92D or slave station.
- (5) **Output status setting for the case of a CPU stop error  
(Continue/Stop of I/O data exchange)**  
For the case of a CPU stop error on a CPU module where the QJ71PB92D is mounted, whether to continue or stop I/O data exchange with slave station can be specified. (Refer to Section 4.3)
- (6) **Compatibility with multiple CPU system**  
Even when a plurality of CPU modules are installed through the multiple CPU system, this model can be controlled by any CPU module.
- (7) **Self-diagnosis function included**  
The self-diagnosis function allows testing of hardware such as internal memories. (Refer to Section 5.4)

## 2. SYSTEM CONFIGURATION

This chapter describes the system configuration of QJ71PB92D.

### 2.1 Applicable System

This section describes applicable systems.

(1) Mountable modules, No. of mountable modules, and mountable base unit

(a) When mounting to CPU module

The following shows the mountable CPU modules, No. of mountable modules, and mountable base unit of the QJ71PB92D.

Power shortage may occur depending on the combination with other mounted modules or the number of mounted modules.

When mounting modules, pay attention to the power supply capacity.

When the power shortage occurs, review the combination of modules to be mounted.

Mountable CPU module		No. of mountable modules* <sup>1</sup>	Mountable base unit* <sup>2</sup>		
CPU type	CPU model name		Main base unit	Extension base unit	
Programmable controller CPU	Basic model QCPU	Q00JCPU	Up to 8		
		Q00CPU	Up to 24	○	○
		Q01CPU			
	High Performance model QCPU	Q02CPU	Up to 64		
		Q02HCPU			
		Q06HCPU		○	○
		Q12HCPU			
	Process CPU	Q12PHCPU	Up to 64	○	○
		Q25PHCPU			
	Redundant CPU	Q12PRHCPU	Not mountable	×	×
		Q25PRHCPU			
	Universal model QCPU	Q02UCPU	Not mountable	×	×
		Q03UDCPU	Up to 64	○	○
		Q04UDHCPU		○	○
Q06UDHCPU		○		○	

○: Mountable, ×: Not mountable

\*1 Limited to the range of the number of I/O points in the CPU module

\*2 Mountable on any I/O slot of the mountable base unit.

POINT
(1) The number of mountable modules is restricted depending on the automatic refresh setting on the QJ71PB92D. For details, refer to Section 5.1.5.
(2) Use a QCPU whose first five digits of serial No. is 02092 or later to use the separation prevention function. If this function is used in any other models, I/O data may be identified as invalid values.

- (b) When mounting to remote I/O station of MELSECNET/H  
 The QJ71PB92D cannot be mounted to remote I/O station of the MELSECNET/H.  
 When using the QJ71PB92D in the MELSECNET/H remote I/O network, mount it to a CPU module of the master station.

(2) Compatibility with multiple CPU system

Please refer to the QCPU User's Manual (Multiple CPU System) before using the QJ71PB92D in the multiple CPU system.

(a) Compatible QJ71PB92D

The function version of the QJ71PB92D has been "B" from the first release and it supports the multiple CPU system.

(3) Online module change

The QJ71PB92D does not support the online module change.

(4) Compatible software packages

The following shows the compatibility between software packages and the system using the QJ71PB92D.

GX Developer: For setting QCPU parameters and creating sequence programs  
 (Required)

GX Configurator-DP: Configuration software for the QJ71PB92D (Required)

(a) For the QJ71PB92D

QJ71PB92D

System		Software Package	
		GX Developer	GX Configurator-DP
Q00J/Q00/Q01CPU	Single CPU system	Version 7 or later	Version 5 or later
	Multiple CPU system	Version 8 or later	
Q02/Q02H/Q06H/ Q12H/Q25HCPU	Single CPU system	Version 4 or later	Version 4 or later
	Multiple CPU system	Version 6 or later	
Q12PH/Q25PHCPU	Single CPU system	Version 7.10L or later	Version 4 or later
	Multiple CPU system		
Q03UD/Q04UDH/ Q06UDHCPU	Single CPU system	Version 8.48A or later	Version 7.02C or later
	Multiple CPU system		

(b) For the QJ71PB92V (QJ71PB92D-compatible function)

QJ71PB92V  
(92D-compatible)

System		Software Package	
		GX Developer	GX Configurator-DP
Q00J/Q00/Q01CPU	Single CPU system	Version 7 or later	Version 5 to 6
	Multiple CPU system	Version 8 or later	Version 7.01B or later *1
Q02/Q02H/Q06H/Q12H/ Q25HCPU	Single CPU system	Version 4 or later	Version 4 to 6 Version 7.01B or later*1
	Multiple CPU system	Version 6 or later	
Q12PH/Q25PHCPU	Single CPU system	Version 7.10L or later	later*1
	Multiple CPU system		
Q03UD/Q04UDH/ Q06UDHCPU	Single CPU system	Version 8.48A or later	Version 7.02C or later
	Multiple CPU system		

\*1 GX Configurator-DP Version 7.01B, only the Web-based online access function cannot be used.

**POINT**

QJ71PB92V  
(92D-compatible)

GX Configurator-DP Version 7.00A cannot be used.  
For GX Configurator-DP Version 7.00A, upgrade it to Version 7.01B or later.  
For version upgrades, please consult your local Mitsubishi representative.

**REMARK**

The following configuration software programs cannot be used on QJ71PB92D.

- SW0D5C PROFIMAP
- MELSEC PROFIMAP Version 1
- MELSEC PROFIMAP Version 2
- MELSEC PROFIMAP Version 3

**(5) Replacement with the QJ71PB92V**

When replacing the QJ71PB92D with the QJ71PB92V (QJ71PB92D-compatible function), use the QJ71PB92V whose serial No. (first five digits) is 09052 or later. (Refer to Section 2.4.)

**POINT**

When replacing the QJ71PB92D with the QJ71PB92V, refer to Appendix 1.

## 2.2 When Used in Multiple CPU System

When using QJ71PB92D in the multiple CPU system, take care of the following.

- The control of QJ71PB92D is performed by any QCPU.
  
- A total of merely 64 sheets of QJ71PB92D is installed for each system. It is not the mountable number of sheets for each controlled QCPU, but the total number of sheets controlled by all QCPU.

## 2.3 Precautions for Configuring a System

### (1) Precaution for parameter writing

- (a) If a parameter is written to the QJ71PB92D that is exchanging I/O data, the I/O data communication is suspended.  
It is restarted after completion of parameter writing.
- (b) Do not change the operation mode from the sequence program during parameter writing.  
Doing so may disable proper station number setting or mode change.
- (c) Do not write parameters from multiple GX Configurator-DPs to a single QJ71PB92D at the same time.  
Doing so makes the parameter values of the QJ71PB92D incorrect.

### (2) Operations performed with the module READY signal (X1D) ON

When performing the following operations, make sure the module READY signal (X1D) is ON.

- To switch over the operation mode with Y11/X11, using the sequence program.
- To set parameters.

If the status of module READY signal (X1D) is ignored and data is read from or written in the buffer memory, the CPU module may detect an error to stop the sequence calculation.

2.4 Checking the Function Version and Serial No.

This section explains how to check the function version and serial No. of the QJ71PB92D.

(1) Checking the "Rating plate" on the side of the module

The serial No. and function version of the module are printed in the SERIAL section of the rating plate.

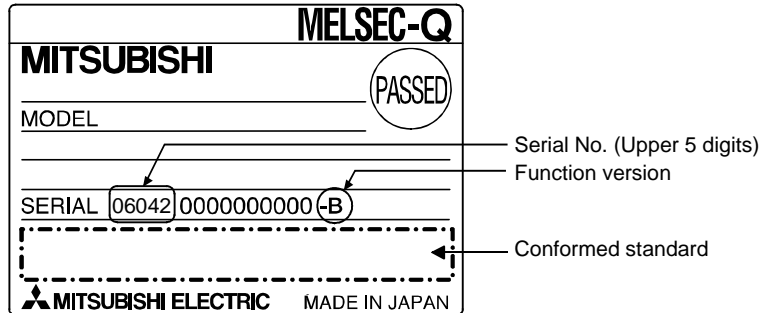

(2) Checking through GX Developer

The following explains how to check the serial No. and function version of the module through GX Developer.

The serial No. and function version are displayed on the "Product information list" or "Module's Detailed Information" screen of GX Developer.

The procedure for checking the serial No. and function version on the "Product information list" screen is shown below.

[Start Procedure]

"Diagnostics" → "System monitor" → "Product inf. List"

Slot	Type	Series	Model name	Points	I/O No.	Master PLC	Serial No	Ver.	Product No.
PLC	PLC	Q	Q03UDCPU	-	-	-	0904200000000000	B	090421091210001-B
0-0	Intelli.	Q	QJ71PB92D	32pt	0000	-	0604200000000000	B	-
0-1	Intelli.	Q	QJ71PB92D (92V)	32pt	0020	-	0905200000000000	D	-
0-2	-	-	None	-	-	-	-	-	-

[Serial No., Ver., Product No.]

- The serial No. of the module is displayed in the "Serial No." column.
- The function version of the module is displayed in the "Ver." column.
- The serial No. (Product No.) shown on the rating plate is displayed in the "Product No." column. \*1

Note that "-" is displayed in the "Product No." column for the QJ71PB92D since this module is not supporting Product No. display.

\*1 The Product No. is displayed in the column only when the Universal model QCPU is used.

POINT
<p>The serial No. described on the rated plate may not match with the serial No. displayed on the product information of GX Developer.</p> <ul style="list-style-type: none"><li>▪ The serial No. on the rated plate describes the management information of the product.</li><li>▪ The serial No. displayed on the product information of GX Developer describes the function information of the product.</li></ul> <p>The function information of the product is updated when adding functions.</p>



### 3. SPECIFICATIONS

This chapter explains the performance and transmission specifications of the QJ71PB92D.

For details of the general specifications, refer to the QCPU User's Manual (Hardware Design, Maintenance and Inspection).

#### 3.1 Performance Specifications

Item		Specifications	
PROFIBUS-DP station type		Class 1 master station	
Transmission specifications	Electrical standard/characteristics	EIA-RS485 compliant	
	Medium	Shielded twisted pair cable (Refer to Section 5.5.1)	
	Network topology	Bus topology (Tree topology when repeaters are used)	
	Data link method	<ul style="list-style-type: none"> <li>Between master station and master station: Token passing method</li> <li>Between master station and slave station: Polling method</li> </ul>	
	Encoding method	NRZ	
	Transmission speed *1	9.6 kbps to 12 Mbps (Refer to (1) in this section)	
	Transmission distance	Differs depending on the transmission speed (Refer to (1) in this section)	
	Max. No. of repeaters	3 repeaters	
	Number of connectable modules (Per segment)	32 per segment*2 (including repeater(s))	
	Number of connectable modules (Per network)	126 per network*2 (total of master stations and slave stations (Refer to Section 3.2.1 (2)))	
	Max. No. of slave stations (Per QJ71PB92D)	60 per QJ71PB92D*2	
	I/O data size	Input data	<ul style="list-style-type: none"> <li>Normal service mode: 32 bytes per slave station</li> <li>Extended service mode: Max. 1920 bytes (Max. 244 bytes per slave station)</li> </ul>
		Output data	<ul style="list-style-type: none"> <li>Normal service mode: 32 bytes per slave station</li> <li>Extended service mode: Max. 1920 bytes (Max. 244 bytes per slave station)</li> </ul>
Number of writes to flash ROM		Max. 100000 times	
No. of occupied I/O points		32 (I/O assignment: 32 intelligent points)	
Internal current consumption (5VDC)		0.57 A	
External dimensions		98(3.86 in.) (H) × 27.4(1.08 in.) (W) × 90(3.54 in.) (D) [mm]	
Weight		0.15 kg	

\*1 The transmission speed is controlled within  $\pm 0.3\%$ . (PROFIBUS part1)

\*2 When a slave used is greater than 32 bytes in the maximum data length of the error information, Max. No. of stations and the Max. No. of slave stations may be less than the above values.

This is because the maximum data length of the slave station error information that the QJ71PB92D can receive varies with the minimum station number and maximum station number of the slave stations set in the parameters. Refer to Section 3.2.3 for details.

For the noise immunity, withstand voltage, insulation resistance and others in the programmable controller system using this module, refer to the power supply module specifications given in the used QCPU User's Manual (Hardware Design, Maintenance and Inspection).

## (1) Transmission distance

Transmission Speed	Transmission Distance	Max. Transmission Distance when Repeater is Used *1
9.6 kbps	1200 m (3937 ft.)/segment	4800 m (15748 ft.)/network
19.2 kbps		
93.75 kbps		
187.5 kbps	1000 m (3281 ft.)/segment	4000 m (13123 ft.)/network
500 kbps	400 m (1312 ft.)/segment	1600 m (5249 ft.)/network
1.5 Mbps	200 m (656 ft.)/segment	800 m (2625 ft.)/network
3 Mbps	100 m (328 ft.)/segment	400 m (1312 ft.)/network
6 Mbps		
12 Mbps		

\*1 The max. transmission distance in the table above is based on the case where 3 repeaters are used.

The calculation formula for the transmission distance extended using a repeater(s) is:

$$\text{Max. transmission distance [m/network]} = (\text{Number of repeaters} + 1) \times \text{Transmission distance [m/segment]}$$

## 3.2 Network Configuration

### 3.2.1 Basic configuration

This section explains the basic PROFIBUS-DP configuration for using the QJ71PB92D as a class 1 master station.

#### (1) System equipment

The following table shows the equipment required for the PROFIBUS-DP system.

System Equipment	Description
Class 1 master station	QJ71PB92D
Configuration tool	<ul style="list-style-type: none"> <li>• For the QJ71PB92D <b>QJ71PB92D</b> GX Configurator-DP Version 4 or later</li> <li>• For the QJ71PB92V (QJ71PB92D-compatible function) *1 <b>QJ71PB92V</b> (92D-compatible) GX Configurator-DP Version 4 to 6 GX Configurator-DP Version 7.01B or later *2</li> </ul>
Slave station	QJ71PB93D, ST1H-PB, etc.
Repeater	Required when 32 or more slave station are connected
PROFIBUS cable	Refer to Section 5.5.1
Bus terminator	

\*1 GX Configurator-DP Version 7.00A cannot be used.

\*2 GX Configurator-DP Version 7.01B, only the Web-based online access function cannot be used.

## (2) Network configuration

In the PROFIBUS-DP system configuration, the following conditions must be satisfied:

- (a) Number of connectable modules in an entire network (With repeaters are used)

Master station <sup>\*1</sup> + Slave station  $\leq 126$

\*1 Including the QJ71PB92D

- (b) Number of connectable modules per segment

Master station <sup>\*1</sup> + Slave station + repeaters <sup>\*2</sup>  $\leq 32$

\*1 Including the QJ71PB92D

\*2 A repeater is counted for both segments.

- (c) No. of repeaters

Up to 3 repeaters can be used for communication between the QJ71PB92D and any slave station.

- (d) Number of connectable slave stations per QJ71PB92D

Up to 60 slave stations can be connected to a single QJ71PB92D.

- (e) Multi-master system (The QJ71PB92D only (QJ71PB92D))

When using other vendor's products as master stations

When a communication chip of ASPC2 STEP C mode or equivalent is used, the master station cannot be connected to the PROFIBUS-DP in which the QJ71PB92D is included.

To use a master station with such a communication chip, configure another network.

For the communication chip currently used, consult its manufacturer.

3.2.2 Applicable configuration

(1) Maximum configuration with no connected

Master station (QJ71PB92D): 1

Slave station: 31

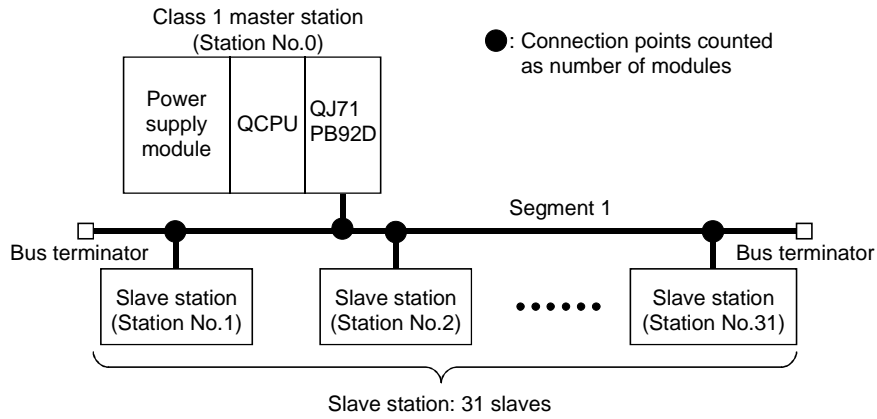

\* A maximum of 32 slaves can be connected to 1 segment.

(2) Maximum configuration with a repeater connected

Master station (QJ71PB92D): 1

Slave station: 60

Repeater: 1

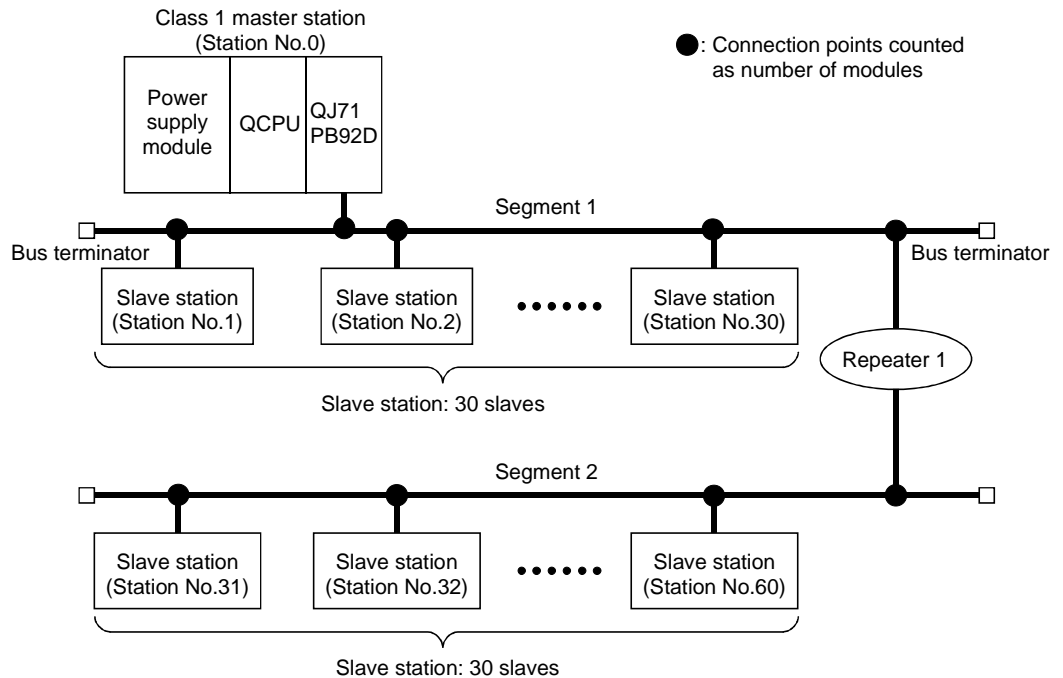

\* In the above configuration a maximum of 60 slaves can be connected.

(3) Maximum configuration with 3 repeaters connected

Master station (QJ71PB92D): 1

Slave station: 60

Repeaters: 3

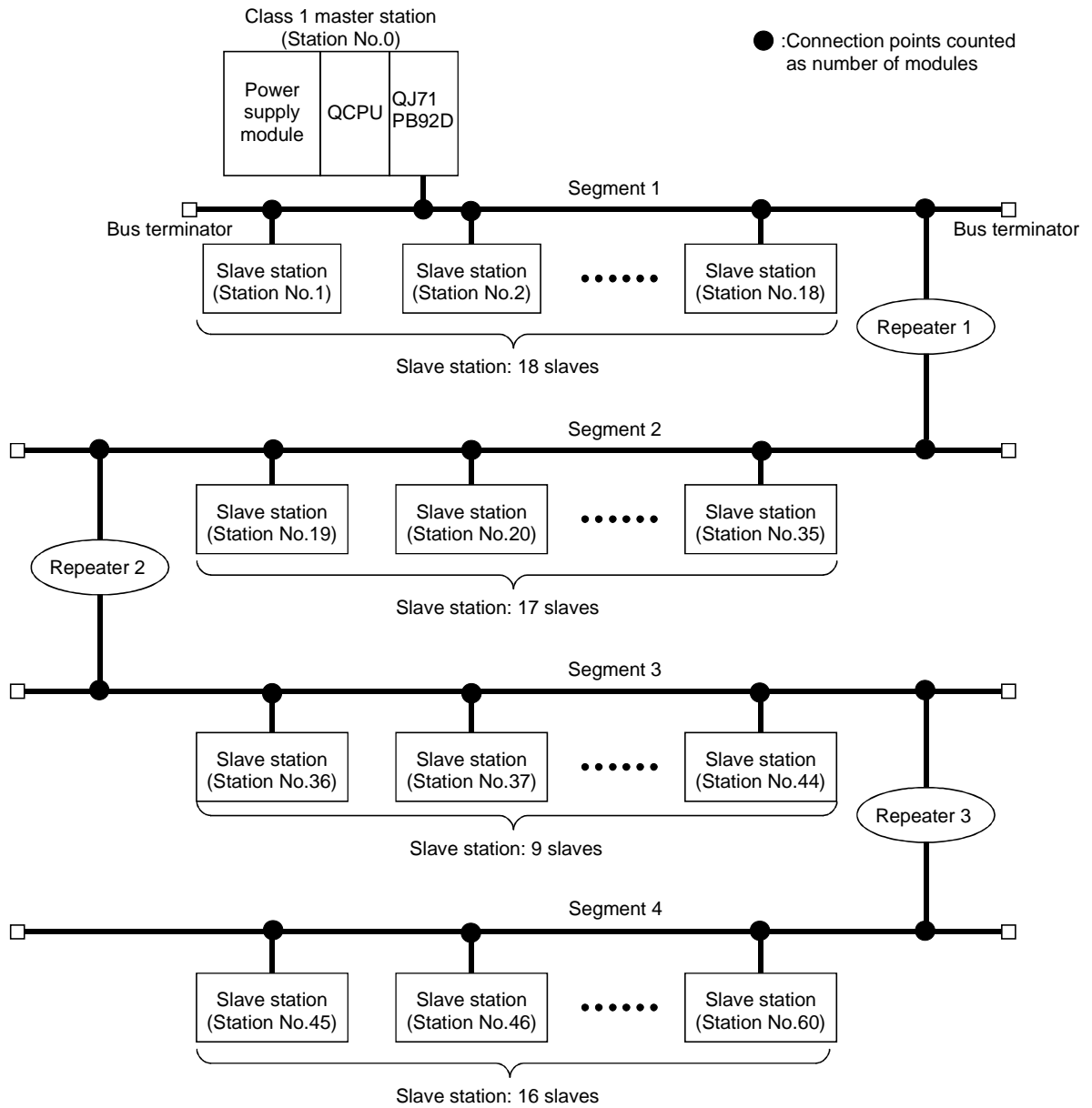

\* In the above configuration, up to 60 slave stations can be connected.  
The difference from configuration (2) is in the fact that the transmission distance can be extended.

(4) Maximum configuration with multiple master stations connected (Multi-master system)

More than one master station with different station numbers can be connected to the same network.

By using three QJ71PB92Ds as shown below, up to 123 slave stations can be connected.

Master station (QJ71PB92D): 3

Slave station: 123

Repeaters: 4

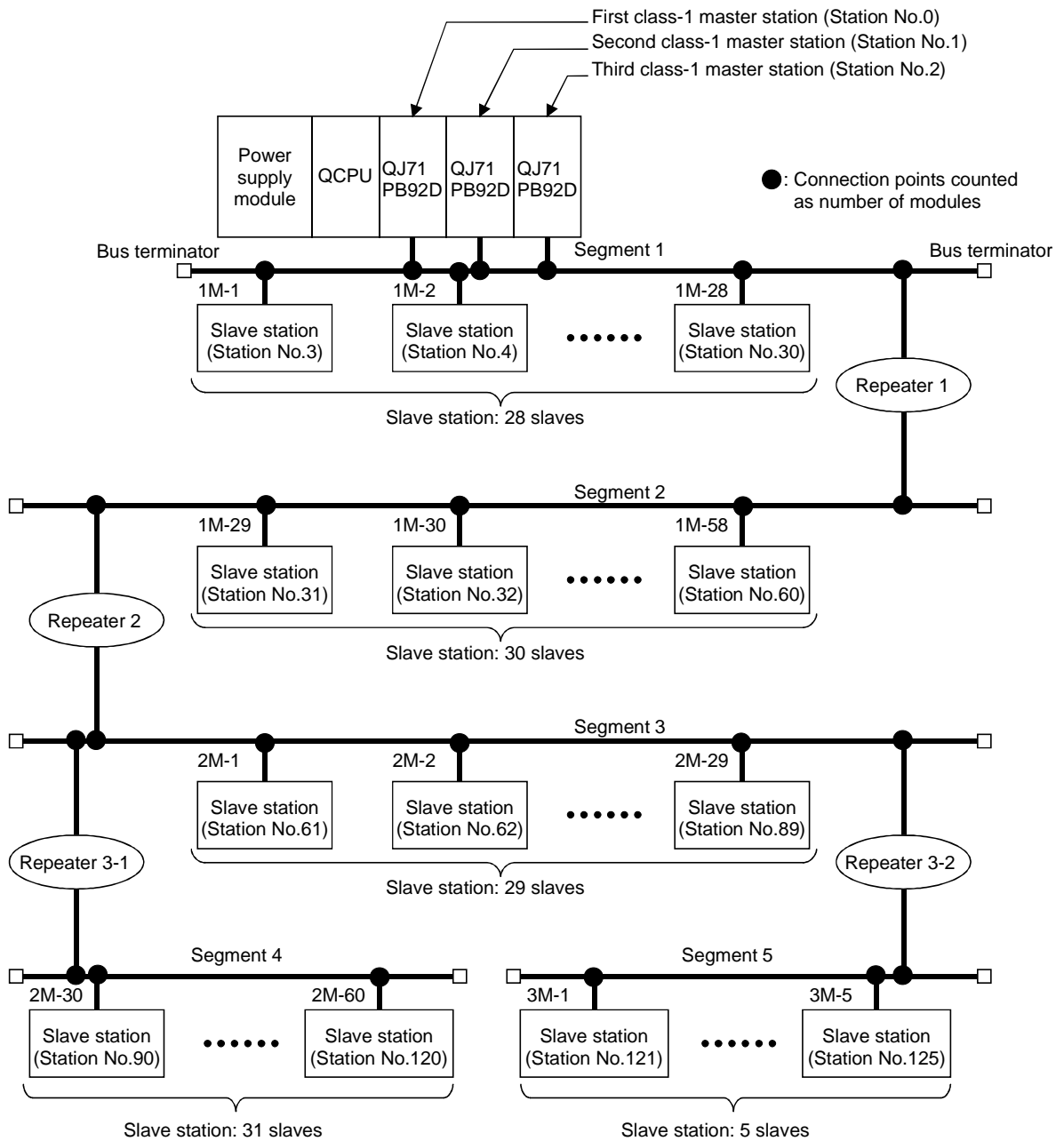

1M-□ : Slave station controlled by the 1st class-1 master station (Station No. 0). (□ indicates count No.)

2M-□ : Slave station controlled by the 2nd class-1 master station (Station No. 1). (□ indicates count No.)

3M-□ : Slave station controlled by the 3rd class-1 master station (Station No. 2). (□ indicates count No.)

POINT
-------

In configurations that use multiple master stations (multimaster configuration), when reconnecting a cable after disconnecting a PROFIBUS cable for 1 master that is exchanging data at a low baud rate, the communications of the master for which the cable is not disconnected could stop and the slave output could be turned off.

To prevent this, the master PROFIBUS cable must be secured with a screw.

In addition, there is a high possibility that the above phenomena can be avoided if care is taken with the following points when configuring a system.

- (1) Set the slave watchdog timer setting value to larger than  $(T_{TR} \times G)/BR$ .

However,

$T_{TR}$  : Target token rotation time (Unit: Bit Time)

G : Gap update factor

BR : Baud rate (Unit: bps)

- (2) Use a high baud rate.
- (3) The HSA (Highest Station Address) value is made to match the maximum station No. that is actually connected.



3.2.3 Number of connectable slaves

Please calculate the number of the slave which can be connected under the following (1) and (2) conditions.

(1) Restrictions on maximum data length of slave station error information

The maximum data length of the slave station error information that the QJ71PB92D can receive varies with the minimum station number and maximum station number of the slave stations set in the parameters, and can be calculated using the following expression.

$$\text{Maximum data length of acceptable error information [bytes]} = \text{Min} \left( \frac{12600}{N - 10}, 244 \right)$$

$$N = \text{Min}((a - b + 1) \times 5, 300)$$

a: Maximum station number of slave station

b: Minimum station number of slave station

\* Min(a, b) = A or B, whichever is smaller

If the maximum data length (Max\_Diag\_Data\_Len) of the error information described in the GSD file of a slave station is greater than the value calculated by the above expression, normal communication may not be made with that slave station.

If normal communication cannot be made, try the following methods:

- (a) Set the station numbers of the slave stations with no unused numbers in between.
- (b) Make setting on the slave station side to shorten the maximum data length of the error information. (If possible)
- (c) Using two or more QJ71PB92D's, reduce the number of slave stations per module.

(2) Restrictions on parameter data length of slave station

The parameter size which can be set in QJ71PB92D should meet the following formula.

Note that the system construction which does not meet the following formula causes the error of 1302H. (Refer to Section 3.4.2 (4))

$$5 + \sum_{i=1}^n (\text{number of parameter blocks of each slave station}) \leq 128$$

n = number of slave stations

∑ (number of parameter blocks of each slave station) = sum total of the numbers of parameter blocks calculated by each slave station

The number of parameter blocks for each station is decided by the parameter size of the station as follows.

Parameter size of each slave station	Number of blocks of each slave station
246 bytes or less	1 block
247 to 480 bytes	4 blocks
481 to 720 bytes	5 blocks
721 to 762 bytes	6 blocks

Calculate the parameter size of each slave station using the following formula.

$$\text{Parameter size of each slave station} = 31 + (\text{User\_Param data length}) + (\text{configuration data length}) + \alpha$$

(a) User\_Param data length

The value of User\_Prm\_Data usage on the screen displayed when Select Modules is selected on the slave station setting screen of GX Configurator-DP.

(b) Configuration data length

The value differs depending on the slave station type as shown below.

1) Module type slave station

Sum of the number of Module set values, which are described in the GSD file of the slave station, of the modules registered to the [Slot] Installed Module list.

(Example) [Slot] Installed Module registration status of GX Configurator-DP

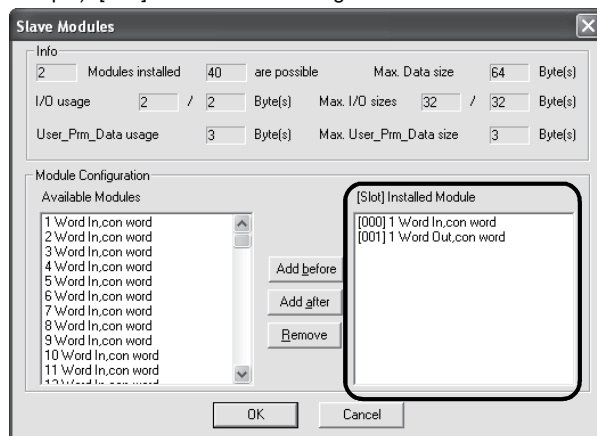

SD file description

Module="1 Word In,con word" 0x50

Module="1 Word Out,con word" 0x60

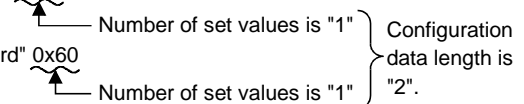

2) Block type slave station

Number of Module set values described in the GSD file of the slave station.

(Example) GSD file description

Module="1 Byte Out,3 Byte In" 0x20,0x12

As the number of set values is "2", the configuration data length is "2".

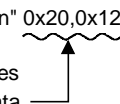

(c)  $\alpha$  (constant)

$\alpha = 2$ : When the slave station has only input or output

$\alpha = 4$ : When the slave station has both input and output

(example)

When the system is constructed using only the slave stations with 520 bytes parameter, QJ71PB92D can connect with up to the following number of the slave stations.

When the parameter size is 520 bytes, the number of the parameter block is five blocks.

$$5 + (5 \times n) \leq 128 \quad : n = \text{number of slaves}$$

$$n \leq \frac{128 - 5}{5} = 24.6$$

$$n = 24$$

The calculation mentioned above tells that QJ71PB92D can connect with up to 24 slave stations.

When 25 slave stations or more are set by the parameter, QJ71PB92D detects the error of 1302H.

3.3 I/O Signal

3.3.1 I/O signal list

The following I/O signal assignment is based on the case where the start I/O No. of the QJ71PB92D is "0000" (installed to slot 0 of the main base unit).  
 Device X represents input signals from the QJ71PB92D to the QCPU.  
 Device Y represents output signals from the QCPU to the QJ71PB92D.  
 The following shows the I/O signals to/from the QCPU.

Signal direction: QJ71PB92D → QCPU		Signal direction: QCPU → QJ71PB92D	
Device No.	Description	Device No.	Description
X00	Exchange start end signal	Y00	Exchange start request signal
X01	Communication trouble detection signal	Y01	Communication trouble detection signal reset
X02	Communication trouble area clear end signal	Y02	Communication trouble area clear request signal
X03	Use prohibited	Y03	Communication trouble area type selection signal
X04	Global control end signal	Y04	Global control request signal
X05	Global control error end signal	Y05	Use prohibited
X06	Use prohibited	⋮	
⋮		Y0B	
⋮		Y0C	
⋮		Y0D	Restart request signal
⋮		Y0E	Use prohibited
X0F		⋮	
X10	Operation mode signal	Y10	
X11	Operation mode change completion signal	Y11	Operation mode change request signal
X12	Use prohibited	Y12	Use prohibited
⋮		⋮	
X1A	⋮		
X1B	Communication READY signal	⋮	
X1C	Use prohibited	⋮	
X1D	Module READY signal	⋮	
X1E	Use prohibited	⋮	
X1F	Watchdog timer error signal	Y1F	

**POINT**

Do not output (turn ON) the "Use prohibited" signals.  
 Doing so may cause the programmable controller system malfunction.

## 3.3.2 I/O signal detail description

- (1) Exchange start request signal (Y00), exchange start end signal (X00)
- (a) Turn ON the exchange start request signal (Y00) to start I/O data exchange.
  - (b) When I/O data exchange is started after turning ON the exchange start request signal (Y00), the exchange start end signal (X00) turns ON.
  - (c) The exchange start end signal (X00) turns OFF in any of the following cases:
    - When the exchange start request signal (Y00) is turned OFF
    - When an error causing stop of I/O data exchange occurs
    - When parameters are currently being written to the QJ71PB92D from GX Configurator-DP
    - When the operation mode of the QJ71PB92D has been changed
    - When a communication error has occurred on a slave station. (Only when the master parameter, "Error action flag" is checked)

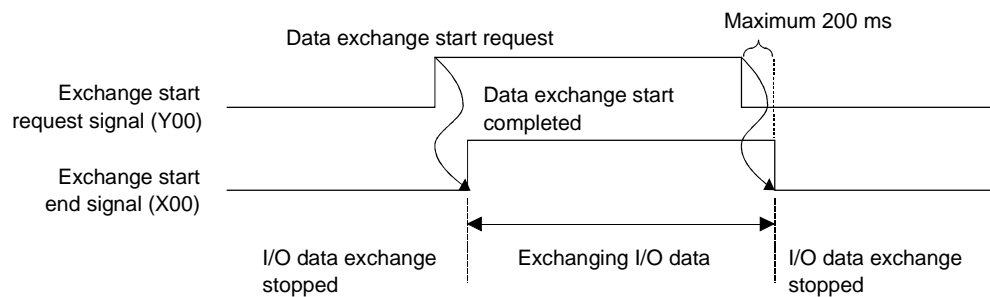

- (d) Use these signals as interlock signals when reading/writing I/O data.
- (e) Write the initial values of the output data to the buffer memory before turning ON the exchange start request signal (Y00).

(2) Communication trouble detection signal reset (Y01), communication trouble detection signal (X01)

- (a) The communication trouble detection signal (X01) turns ON when a communication failure is detected after the time preset in the trouble no information time setting area (Un\G2084) has elapsed. The following processing is performed at the same time that the communication trouble detection signal (X01) turns ON:
  - The RSP ERR. LED turns ON.
  - The trouble information is stored in the communication trouble area (Un\G2040 to Un\G2079).
  - The expansion trouble information is stored in the expansion communication trouble area (Un\G2096 to Un\G2110).
  - The corresponding bit in the Slave status area (Un\G2112 to Un\G2116) of the station that sent the trouble information turns ON.
- (b) The communication trouble detection signal (X01) is turned off when the communication trouble detection signal reset signal (Y01) is turned ON or when communication failure is all resolved. At this time, the RSP ERR. LED turns off.
- (c) The communication trouble detection signal reset (Y01) is turned OFF after it has been confirmed that the communication trouble detection signal (X01) has been turned off.
- (d) The following sequence is used.

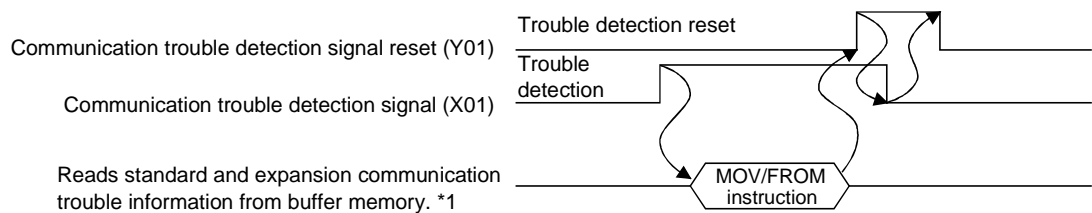

\* 1 Communication trouble area (Un\G2040 to Un\G2079)  
Expansion communication trouble area (Un\G2096 to Un\G2110)

POINT
<p>(1) While the communication trouble detection signal reset (Y01) is ON, another communication failure may occur. In such cases, the QJ71PB92D detects a communication trouble again. (The communication trouble detection signal (X01) turns ON and the RSP ERR. LED lights up.) To turn OFF the communication trouble detection signal (X01), switch the communication trouble detection signal reset (Y01) from OFF to ON, or remove the communication error cause.</p> <p style="text-align: center;">Even if Y01 is ON, a other communication trouble is detected.</p> <p>When successive communication failures occur, turning ON the communication trouble detection signal reset (Y01) may not turn OFF the communication trouble detection signal (X01). In such a case, turn OFF the communication trouble detection signal reset (Y01) and then ON again.</p>
<p>(2) When the communication trouble detection signal (X01) is turned OFF by the communication trouble detection signal reset (Y01) while the target communication failure remains, this failure is not detected again even if the communication trouble detection signal reset (Y01) is turned OFF.</p> <p style="text-align: center;">Current trouble is not detected again by turning OFF Y01.</p>

**REMARK**

The slave status area is automatically cleared when a communication failure is removed.  
Turning ON the communication trouble detection signal reset (Y01) does not clear this area.

- (3) Communication trouble area clear request signal (Y02), communication trouble area clear end signal (X02)
- (a) Turn ON the communication trouble area clear request signal (Y02) when clearing the following information:
    - Communication trouble area (Un\G2040 to Un\G2079)
    - Expansion communication trouble area (Un\G2096 to Un\G2110)
  - (b) When the communication trouble area clear request signal (Y02) is turned ON, and the processing at clear is completed, the communication trouble area clear end signal (X02) turns ON.
  - (c) After the communication trouble area clear end signal (X02) has turned ON, turn OFF the communication trouble area clear request signal (Y02).
  - (d) Taking corrective actions for the error and turning OFF the communication trouble area clear request signal (Y02) turns OFF the communication trouble area clear end signal (X02).
  - (e) A sequence like the one below is used.

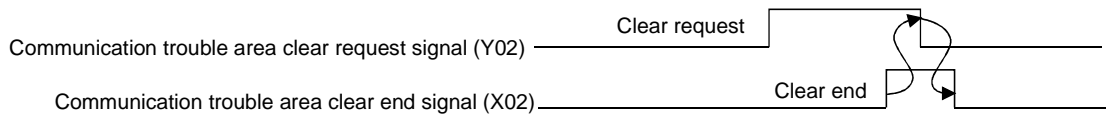



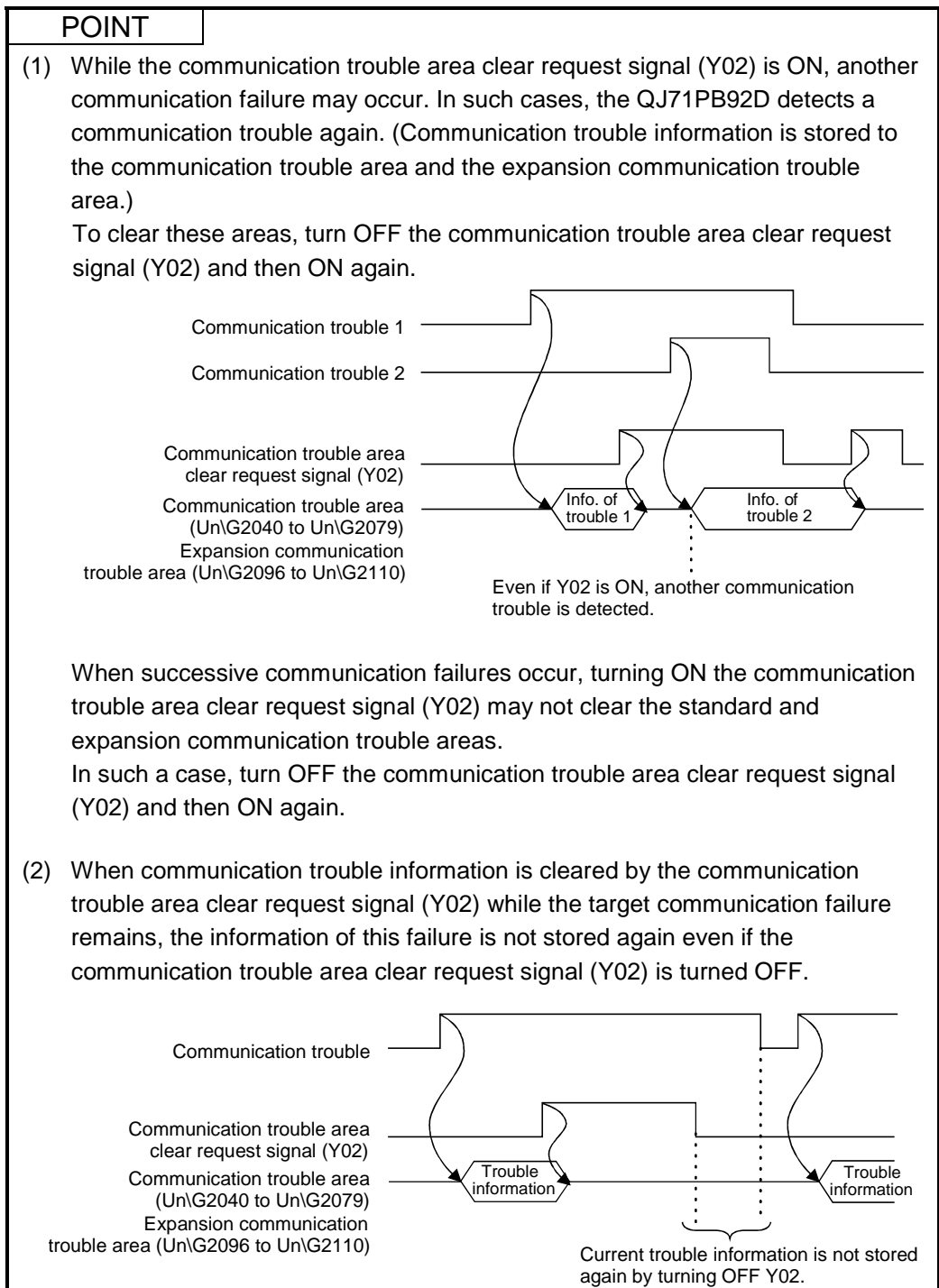

(4) Global control request signal (Y04), global control end signal (X04)

- (a) Turn ON the Global control request signal (Y04) when executing the global control.
- (b) When the Global control request signal (Y04) is turned ON, and global control processing is completed, the Global control end signal (X04) turns ON.
- (c) After the Global control end signal (X04) has turned ON, turn OFF the Global control request signal (Y04).
- (d) Turning OFF the Global control request signal (Y04) turns OFF the Global control end signal (X04).
- (e) Turn ON the Global control request signal (Y04) while the exchange start completed signal (X00) is ON.  
If the Global control request signal (Y04) is turned ON with the exchange start completed signal (X00) OFF, both of the Global control end signal (X04) and Global control error end signal (X05) turn ON.

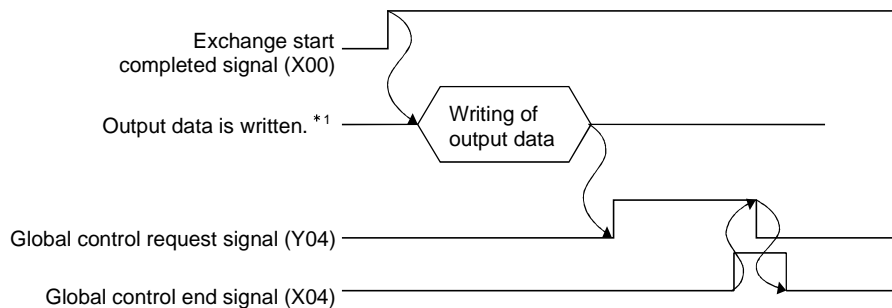

\* 1 Output area (Un\G960 to Un\G1919)

(5) Global control error end signal (X05)

- (a) If the Global control request signal (Y04) is turned ON while the exchange start completed signal (X00) is OFF, both the Global control end signal (X04) and Global control error end signal (X05) turn ON.
- (b) The ON status of the Global control error end signal (X05) means that the global control has failed.  
Remedy the cause of the error, and execute the global control again.
- (c) The slave I/O is not held/deleted when the global control error end signal (X05) is on.
- (d) Turning OFF the Global control request signal (Y04) turns OFF the Global control error end signal (X05).

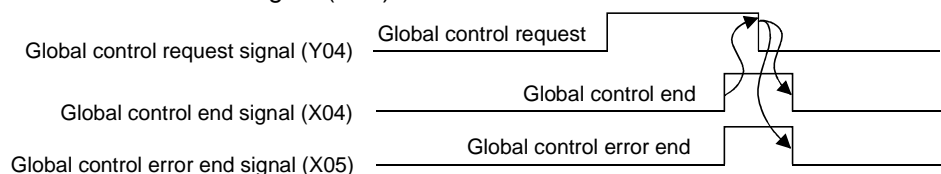

**REMARK**

For details on the global control, refer to Section 4.1.2.

(6) Operation mode signal (X10)

Indicates whether the current operation mode is the parameter setting mode (MODE 1) or not.

ON: Parameter setting mode (MODE 1)

OFF: Normal service mode (MODE 0), extended service mode (MODE E), self-diagnosis mode (MODE 2), initialization mode of flash ROM

(7) Operation mode change request signal (Y11), operation mode change completion signal (X11)

(a) Turn ON the Operation mode change request signal (Y11) when changing the operation mode to the one set in the Operation mode change request area (Un\G2255).

The operation mode can be changed without resetting the QCPU.

(b) Turning ON the Operation mode change request signal (Y11) clears the information of the Operation mode change result area (Un\G2256).

(c) The Operation mode change completion signal (X11) turns ON when the operation mode is changed, and the result of the change is stored to the Operation mode change result area (Un\G2256).

(d) Make sure that 0<sub>H</sub> is stored in the Operation mode change result area (Un\G2256), and turn OFF the Operation mode change request signal (Y11).

(e) Turning OFF the Operation mode change request signal (Y11) turns OFF the Operation mode change completion signal (X11).

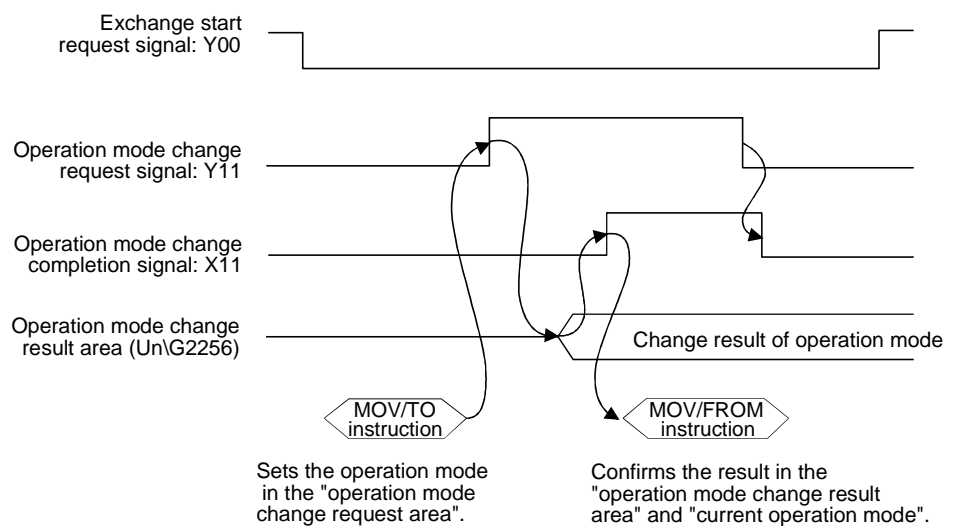

**IMPORTANT**

When the operation mode change request signal (Y11) is on, do not turn off the power or reset the QCPU during registration of the operation mode to the flash ROM. To do so may result in repair of the QJ71PB92D. Turn the power off or reset the QCPU after the operation mode change completion signal (X11) has turned on.

(8) Communication READY signal (X1B)

- (a) The Communication READY signal (X1B) turns ON when the Module READY signal (X1D) turns ON and I/O data exchange is ready to be started. (The signal turns ON only in the Normal service mode (MODE 0) and Extended service mode (MODE E).)
- (b) The signal turns OFF when an error disabling I/O data exchange occurs on the QJ71PB92D.
- (c) Use the signal as an interlock signal for when turning ON the exchange start request signal (Y00).

(9) Module READY signal (X1D)

- (a) This signal turns ON when the QJ71PB92D is started up. (This signal turns ON regardless of the operation mode.)
- (b) It is OFF in the following cases.
  - When the QJ71PB92D is not ready
  - During execution of operation mode change

(10) Watchdog timer error signal (X1F)

- (a) This signal turns ON when a watchdog timer error occurs on the QJ71PB92D.
- (b) The Watchdog timer error signal (X1F) does not turn OFF until:
  - The programmable controller is turned OFF and back ON again
  - The QCPU is reset.

(11) Communication trouble area type selection signal (Y03)

- (a) This signal is used to select the communication trouble area type (ring type or fixed type).  
 ON: Fixed type  
 OFF: Ring type
- (b) This signal becomes valid when the exchange start (Exchange start request signal (Y00) is ON) or communication trouble area clear request signal (Y02) is ON.

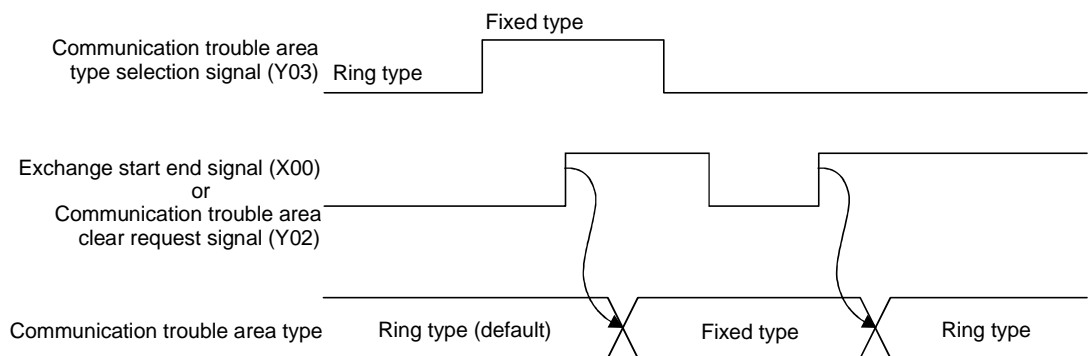

When the exchange start request signal (Y00) or communication trouble area clear request signal (Y02) turns ON, selection of the communication trouble area type selection signal (Y03) is enabled.

- (c) When employing the fixed type, the communication trouble area type selection signal (Y03) must be constantly ON.  
 For the ring type, the communication trouble area type selection signal (Y03) must be constantly OFF.

**(12) Dedicated instruction valid signal (Y0C)**

- (a) This signal is used when the dedicated instruction for separation prevention is validated.  
ON: Read/Write by dedicated instruction is validated.  
OFF: Read/Write by dedicated instruction is invalidated.
- (b) Keep the signal turned ON while the dedicated instruction is being used.
- (c) When using the data separation prevention function (automatic refresh) by the GX Configurator-DP, turn OFF the dedicated instruction valid signal (Y0C).

**(13) Restart request signal (Y0D)**

- (a) If the QJ71PB92D has gone down for some reason (the FAULT LED: ON, the module READY signal (X1D): OFF), turning the Restart request signal (Y0D) OFF, ON and OFF again restarts the QJ71PB92D.
- (b) After the QJ71PB92D is restarted, the status is the same as after:
  - The programmable controller is turned OFF and back ON again
  - The QCPU is reset.

## 3.4 Buffer Memory List

## 3.4.1 Buffer memory/configuration

The configuration of the buffer memory used to receive and send data with the QJ71PB92D and the programmable controller CPU is described below.

Buffer memory address decimal (Hexadecimal)	Area name	Description
0 (0 <sub>H</sub> )	Input area	This is the area that stores the input data from the slave.
959 (3BF <sub>H</sub> )		
960 (3C0 <sub>H</sub> )	Output area	This is the area that stores the output data to the slave.
1919 (77F <sub>H</sub> )		
1920 (780 <sub>H</sub> )	Address information area	This is the area that shows the station number of slave station and I/O data length.
2039 (7F7 <sub>H</sub> )		
2040 (7F8 <sub>H</sub> )	Communication trouble area	This is the area that shows the trouble information that occurred during communication.
2079 (81F <sub>H</sub> )		
2080 (820 <sub>H</sub> )	Slave error information cancel area	This is the area that sets the data that masks the slave trouble information.
2081 (821 <sub>H</sub> )	Global control area	This is the global control function hold/cancel selection area.
2082 (822 <sub>H</sub> )	System area (Use prohibited)	—
2083 (823 <sub>H</sub> )		
2084 (824 <sub>H</sub> )	Trouble no information time setting area	This is used to set the time that does not inform the communication trouble after the exchange start.
2085 (825 <sub>H</sub> )	System area (Use prohibited)	—
2095 (82F <sub>H</sub> )		
2096 (830 <sub>H</sub> )	Expansion communication trouble area	This area shows the expansion information of the trouble information which is occurred during the communication.
2110 (83E <sub>H</sub> )		
2111 (83F <sub>H</sub> )	System area (Use prohibited)	—
2112 (840 <sub>H</sub> )	Slave status area	This is the area that shows the status information of each slave.
2116 (844 <sub>H</sub> )		
2117 (845 <sub>H</sub> )	System area (Use prohibited)	—
2127 (84F <sub>H</sub> )		
2128 (850 <sub>H</sub> )	Input/Output start address area (Extended service mode only)	This is the area that shows the addresses to start the input area and output area of each slave.
2247 (8C7 <sub>H</sub> )		
2248 (8C8 <sub>H</sub> )	System area (Use prohibited)	—
2253 (8CD <sub>H</sub> )		
2254 (8CE <sub>H</sub> )	Current operation mode area	This area indicates the operation mode of the QJ71PB92D when it has started up.
2255 (8CF <sub>H</sub> )	Operation mode change request area	In this area, set the operation mode of the QJ71PB92D which you want to choose.
2256 (8D0 <sub>H</sub> )	Operation mode change result area	This area indicates the execution result of the operation mode change request.
2257 (8D1 <sub>H</sub> )	Local station number display area	Area in which the station number of the local station is stored.
2258 (8D2 <sub>H</sub> )	Self-diagnosis status code area	Area in which the code indicating the status of the self-diagnosis during the execution of the diagnosis is stored.
2259 (8D3 <sub>H</sub> )		
3775 (EBF <sub>H</sub> )	System area (Use prohibited)	—

**POINT**

Do not write any data in the "system area (Use prohibited)" of the buffer memory. If data is written to the "system area (Use prohibited)", there is a risk that the programmable controller system may malfunction.

3.4.2 Buffer memory detailed description

(1) INPUT area (Un\G0 to Un\G959)

Data input from slave stations are stored in this area.

The specifications of the input area differ depending on the operation mode of the QJ71PB92D.

**POINT**

(1) Data are assigned to the input area in the order of GX Configurator-DP parameter settings (in the order of station numbers).  
The actual assignment order can be confirmed in the Address information area (Un\G1920 to Un\G2039) or in Slave List of GX Configurator-DP.

Slave List						
Index	FDL Addr	Link Status	Input Addr.	Input Size	Output Addr.	Output Size
1	3	Link	0	28	960	28
2	10	Link	14	20	974	0
3	32	No Link	24	14	974	14

Order of assignment →

Last known CPU Error  
No Error

(2) The buffer memory is reassigned if parameters are modified (deletion or addition of some slave stations) in GX Configurator-DP.  
Check the sequence program after modifying the parameters.  
If there are slave stations to be connected in the future, set them as reserved stations in the parameter setting.  
Doing so eliminates the need to check the sequence program.

(3) The input area of the QJ71PB92D does not store input data of the slave station that has become incapable of exchanging I/O data and whose bit in the slave status area (Un\G2113 to Un\G2116) has turned ON.  
For the slave station, the input area holds the data that were stored before the failure of I/O data exchange.

(a) Normal service mode (MODE 0)

In the normal service mode (MODE 0), 60 stations are allocated to the input area with 32 bytes (16 words) reserved for each station.

An unused input area for each slave station stores 00H.

1) Example

In the example shown below, the input data lengths for the first and the second stations are set to 29 bytes and 32 bytes respectively.

Since the input data length for the first slave station is 29 bytes, 00H is stored to the unused area (the upper byte of buffer memory address 14 (EH), and 15 (FH)).

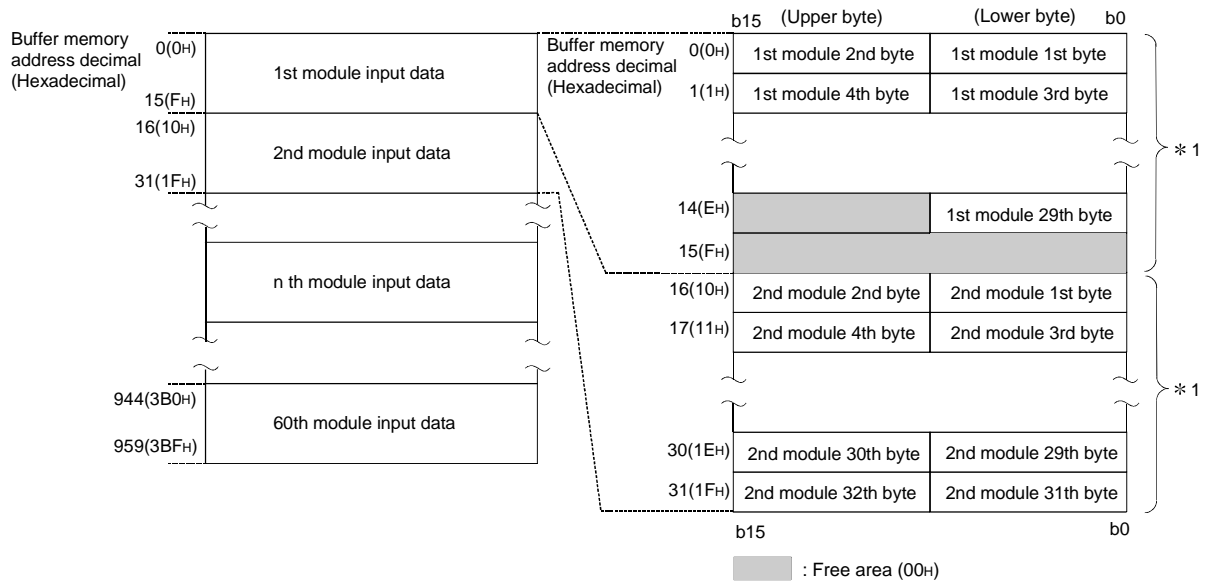



(b) Extended service mode (MODE E)

In the extended service mode (MODE E), the input area is allocated based on the variable data length (in byte units) for each slave station.

1) Setting data length

The data length (in byte units) for each slave station is set in the slave parameter setting (Slave Modules) of GX Configurator-DP.

Note that this slave parameter (Slave Modules) does not have to be set for slave stations with fixed data lengths.

2) Setting range for data length

The maximum data length per module is 244 bytes, and the total data length for all slave station can be set up to 1920 bytes.

When the data length is an odd number of bytes, 00<sub>H</sub> is stored to the final high byte.

3) Example

In the example shown below, the input data lengths for the first and the second stations are set to 23 bytes and 7 bytes respectively.

Since the input data length for the first slave station is 23 bytes, the upper byte of buffer memory address 11 (B<sub>H</sub>) is occupied by 00<sub>H</sub>.

The input data of the next station is assigned starting from the next buffer memory address.

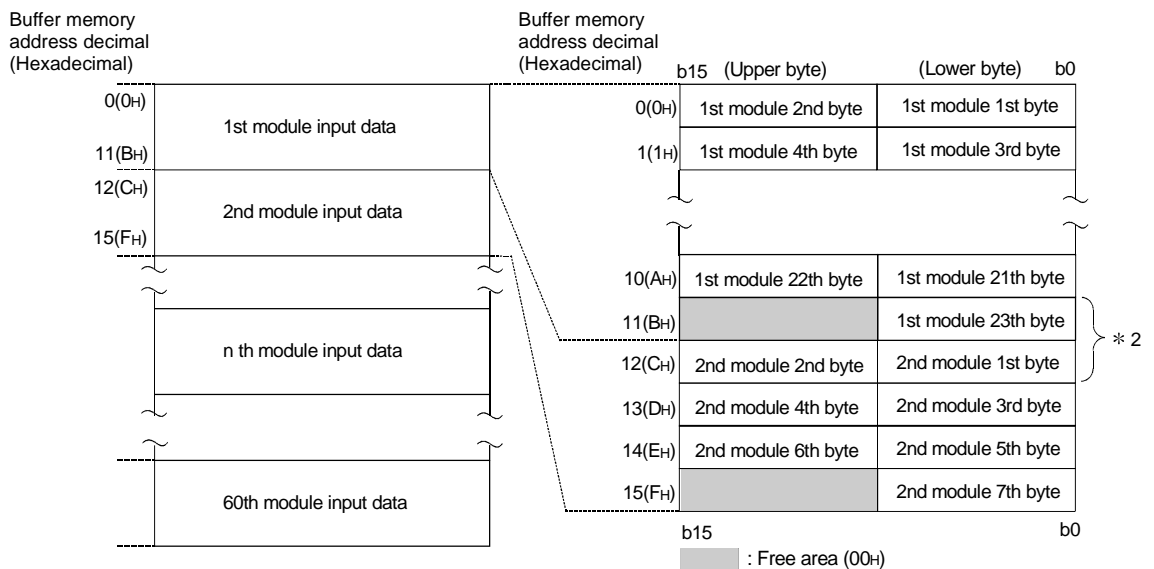

\* 2 When the data length is set to an odd number of bytes, the last upper byte becomes a free area and data for the next station is assigned from the next address.

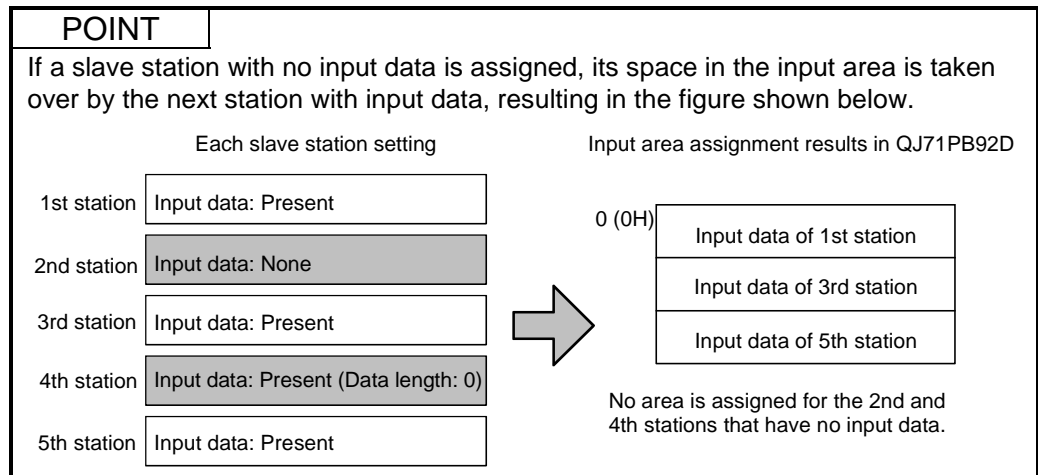

(2) OUTPUT area (Un\G960 to Un\G1919)

Data output from slave stations are stored in this area.

The specifications of the output area differ depending on the operation mode of the QJ71PB92D.

**POINT**

- (1) Data are assigned to the output area in the order of GX Configurator-DP parameter settings (in the order of station numbers).  
The actual assignment order can be confirmed in the Address information area (Un\G1920 to Un\G2039) or in Slave List of GX Configurator-DP.

Slave List						
Index	FDL Addr	Link Status	Input Addr.	Input Size	Output Addr.	Output Size
1	3	Link	0	28	960	28
2	10	Link	14	20	974	0
3	32	No Link	24	14	974	14
Last known CPU Error						
No Error						

Order of assignment

- (2) The buffer memory is reassigned if parameters are modified (deletion or addition of some slave stations) in GX Configurator-DP.  
Check the sequence program after modifying the parameters.  
If there are slave stations to be connected in the future, set them as reserved stations in the parameter setting.  
Doing so eliminates the need to check the sequence program.

(a) Normal service mode (MODE 0)

In the normal service mode (MODE 0), 60 stations are allocated to the output area with 32 bytes (16 words) reserved for each station. Set 00H in an unused output area assigned to each slave station.

1) Example

In the example shown below, the output data lengths for the first and the second stations are set to 1 byte and 3 bytes respectively. Since the output data length for the first slave station is 1 byte, set 00H in the unused area (the upper byte of buffer memory address 960 (3C0H), and 961 (3C1H) to 975 (3CFH)).

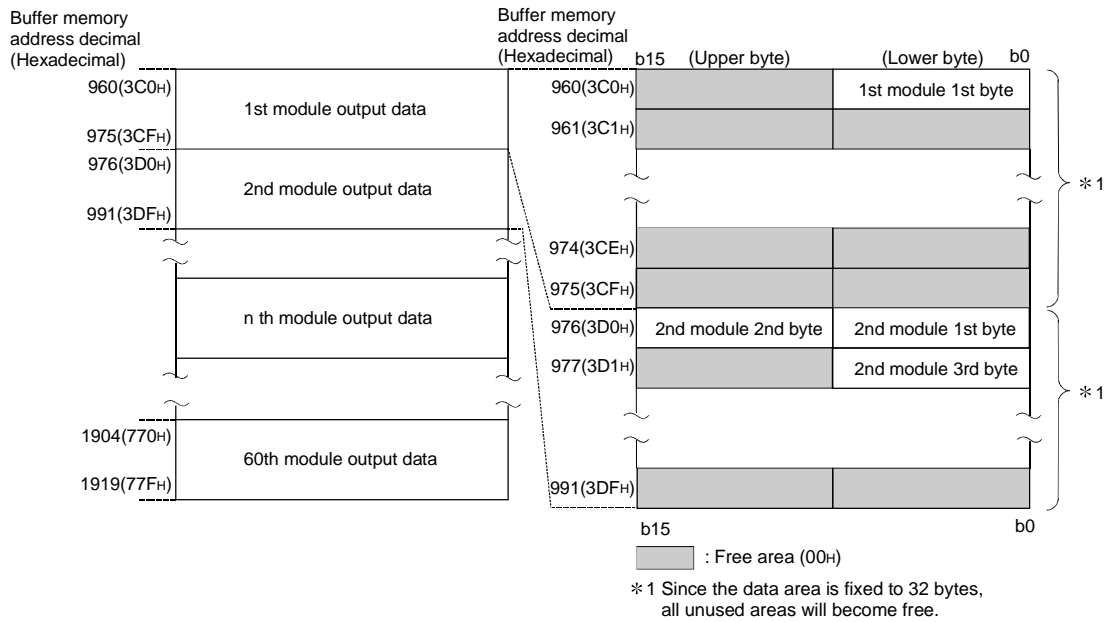

(b) Extended service mode (MODE E)

In the extended service mode (MODE E), the output area is allocated based on the variable data length (in byte units) for each slave station.

1) Setting data length

The data length (in byte units) for each slave station is set in the slave parameter setting (Slave Modules) of GX Configurator-DP.

Note that this slave parameter (Slave Modules) does not have to be set for slave stations with fixed data lengths.

2) Setting range for data length

The maximum data length per module is 244 bytes, and the total data length for all slave station can be set up to 1920 bytes.

When the data length is an odd number of bytes, 00H is stored to the final high byte.

3) Example

In the example shown below, the output data lengths for the first and the second stations are set to 19 bytes and 5 bytes respectively.

Since the output data length for the first slave station is 19 bytes, the upper byte of buffer memory address 969 (3C9H) is occupied by 00H.

The output data of the next station is assigned starting from the next buffer memory address.

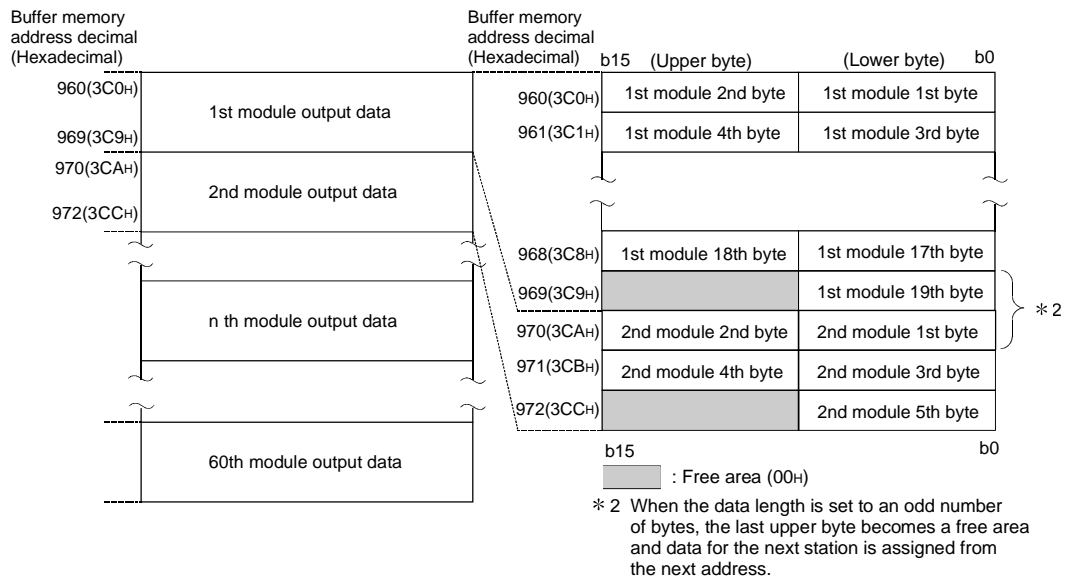

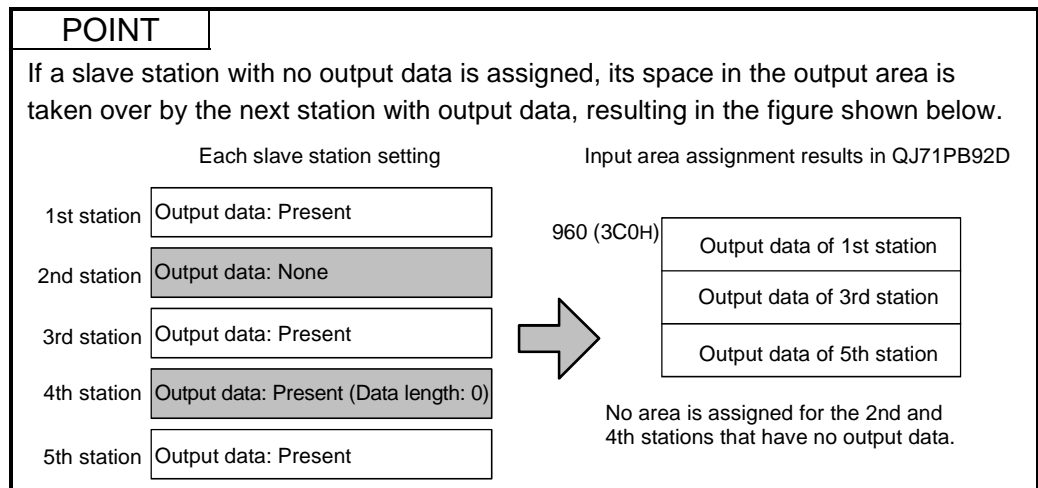

(3) Address information area (Un\G1920 to Un\G2039)

The station number and I/O data length of each slave station are stored in this area.

Information of 60 modules is stored in the Address information area in the same order for each module.

Information for reserved stations is also stored.

(a) Address information area configuration

The address information area configuration is shown below.

Buffer memory Address DEC (HEX)		b15	b8 b7	b0
1920(780H)	Station number of 1st module	1920(780H)	The station number of the 1st module is stored. (Initial value: FFFF <sub>H</sub> )	
1921(781H)	I/O data length of 1st module		0000 <sub>H</sub> to 007D <sub>H</sub> (0 to 125): station number FFFF <sub>H</sub> : No station number assigned	
1922(782H)	Station number of 2nd module	1921(781H)	The input data length of the 1st module is stored. (Initial value: FF <sub>H</sub> ) <sup>*1</sup>	
1923(783H)	I/O data length of 2nd module		The output data length of the 1st module is stored. (Initial value: FF <sub>H</sub> ) <sup>*1</sup>	
to			00 <sub>H</sub> to F4 <sub>H</sub> : Input data length (unit: byte)	00 <sub>H</sub> to F4 <sub>H</sub> : Output data length (unit: byte)
2038(7F6H)	Station number of 60th module		FF <sub>H</sub> : Input data not assigned	FF <sub>H</sub> : Output data not assigned
2039(7F7H)	I/O data length of 60th module			

\*1 The difference between 00<sub>H</sub> and FF<sub>H</sub> is as follows:

00<sub>H</sub>: The set data length is 0 although input or output data is assigned.

FF<sub>H</sub>: Input or output data are not assigned.

The QJ71PB92D assigns the input and output areas according to the information stored in the address information area.

Example: At extended service mode (MODE E)

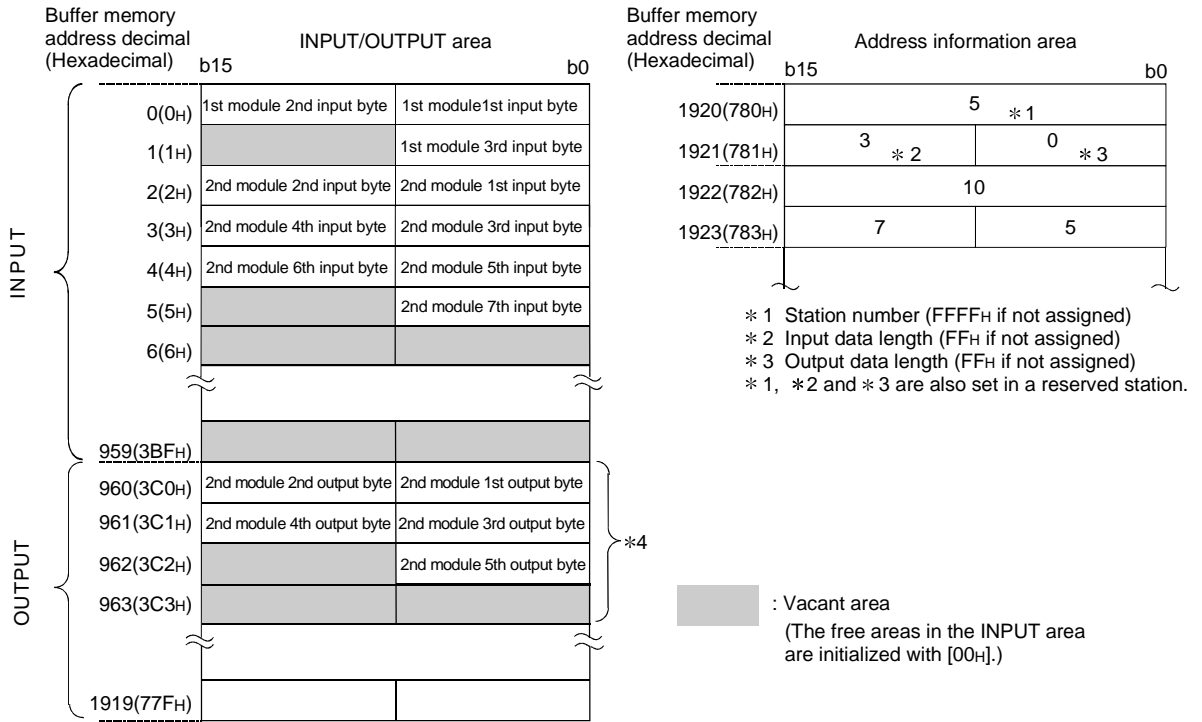
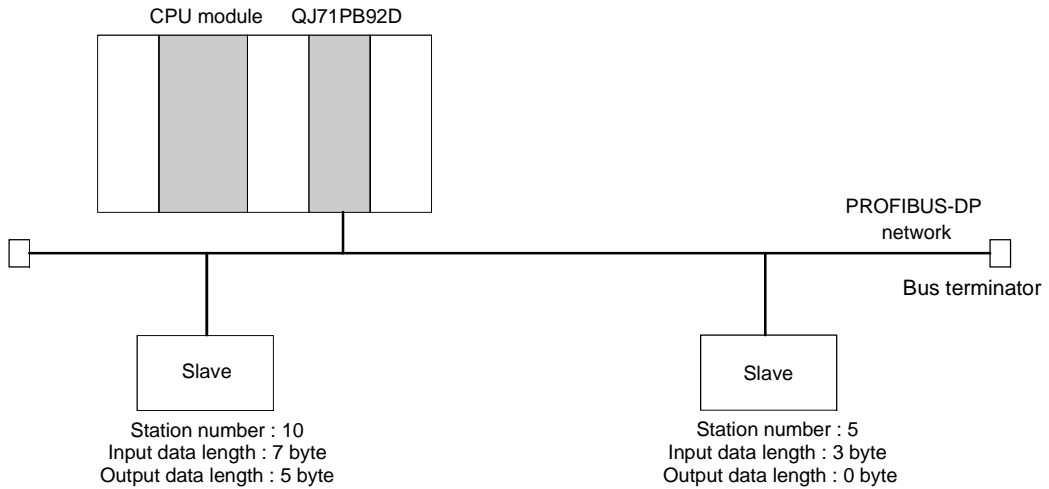

\* 4 Since output from the first station has a data length of 0, no area is allocated in the OUTPUT area.

**POINT**

- (1) Data are assigned to the address information area in the order of GX Configurator-DP parameter settings (in the order of station numbers). The actual assignment order can be confirmed in the Address information area (Un\G1920 to Un\G2039) or in Slave List of GX Configurator-DP.

Order of assignment →

Slave List						
Index	FDL Addr	Link Status	Input Addr.	Input Size	Output Addr.	Output Size
1	3	Link	0	28	960	28
2	10	Link	14	20	974	0
3	32	No Link	24	14	974	14
Last known CPU Error						
No Error						

- (2) The buffer memory is reassigned if parameters are modified (deletion or addition of some slave stations) in GX Configurator-DP. Check the sequence program after modifying the parameters. If there are slave stations to be connected in the future, set them as reserved stations in the parameter setting. Doing so eliminates the need to check the sequence program.



(4) Communication trouble area (Un\G2040 to Un\G2079)

When some kind of trouble occurs during communication the QJ71PB92D stores the contents of the trouble in this area.

(a) Communication trouble area configuration

As shown in the following diagram, a total of 8 pieces of trouble information that consist of the trouble code, detailed data length, and detailed data can be stored.

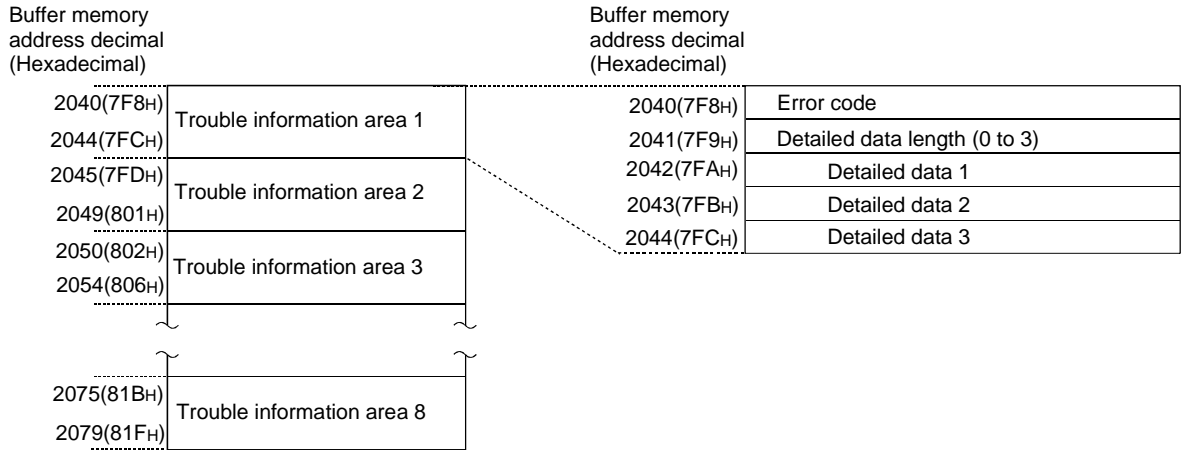

**REMARK**

For error codes and detailed data, refer to Section 9.4.1.

How to store the trouble information can be selected from the ring type and the fixed type by turning ON or OFF the communication trouble area type selection signal (Y03).

1) Ring type

Trouble information is stored in order from the head area of the communication trouble area.

The latest trouble information is always stored in the head area of the communication trouble area.

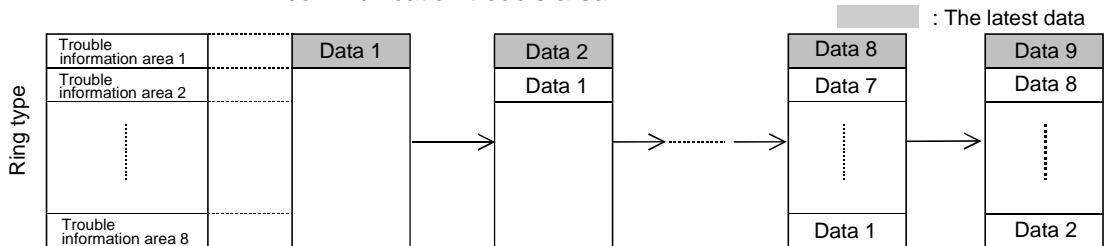

2) Fixed type

Trouble information data in areas 2 to 8 (data 1 to 7) are fixed even if the 9th or later trouble information is generated.

The data of the 9th trouble or later is stored in area 1. (Area 1 only is updated.)

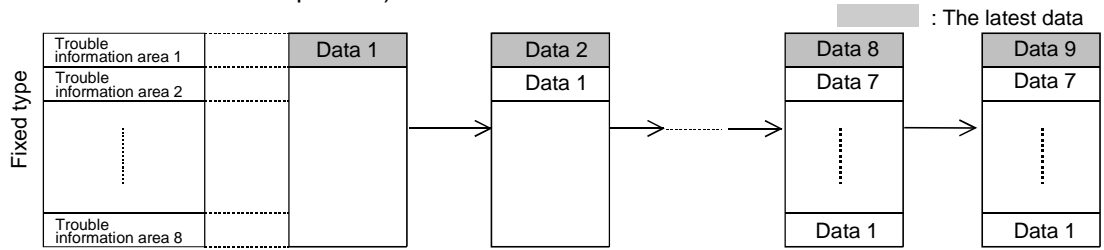

All the trouble information in either type can be cleared by turning ON the communication trouble area clear request signal (Y02).  
 When the communication trouble detection signal reset (Y01) is turned ON, the communication trouble detection signal (X01) turns OFF with the data in the communication trouble area retained.

(5) Expansion communication trouble area (Un\G2096 to Un\G2110)

This area shows the latest expansion trouble information for only one of the latest expansion trouble information in the error code 0200H error information stored in buffer memory 2040 (7F8H) to 2079 (81FH) communication error area (Refer to Section 3.4.2 (4)).

For details of the expansion trouble information, refer to the manual of the slave station.

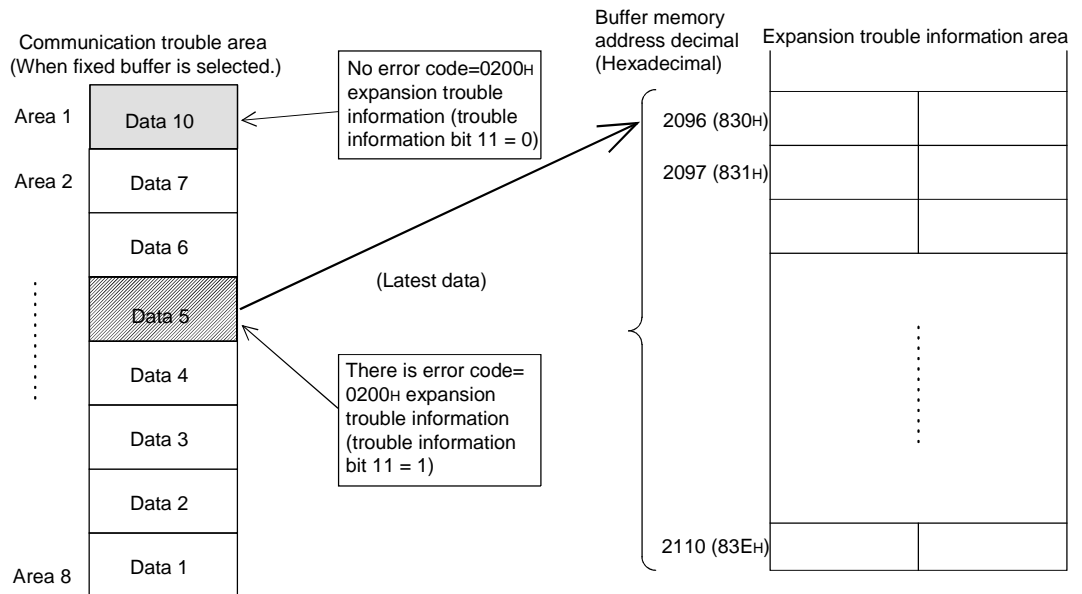

(a) Buffer Memory 2096 (830H)

The latest expansion communication trouble information length stored from buffer memory 2098 (832H) is stored as a byte length unit.

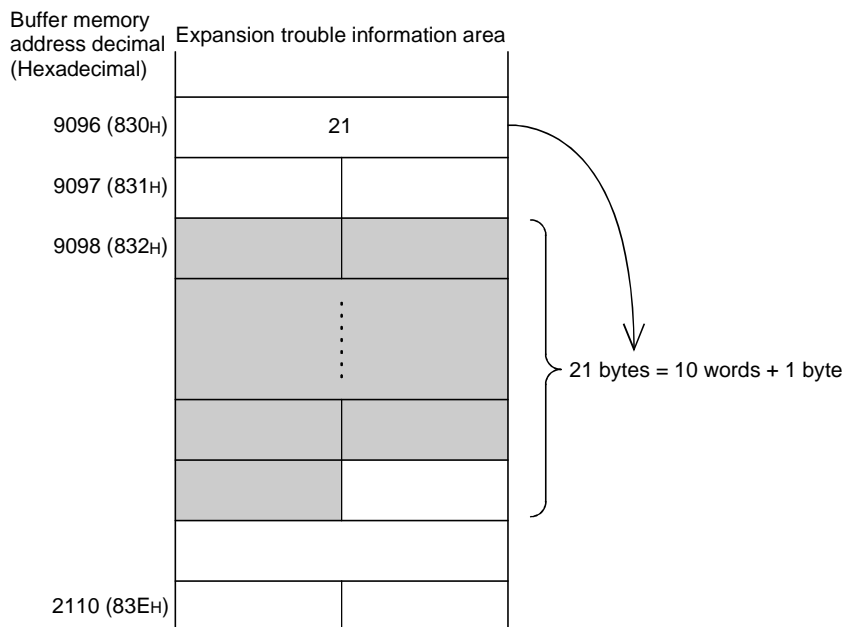

(b) Buffer memory 2097 (831H)

Only bit 7 is valid.

Other bit is fixed in 0.

Bit 7 is turned on when the slave sends expansion trouble information that is 27 bytes or more.

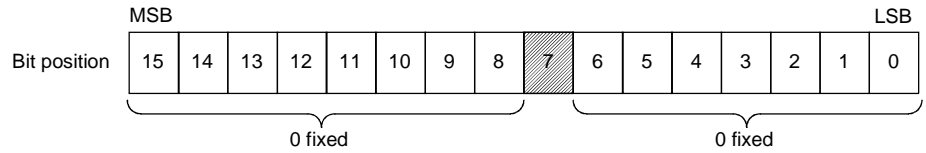

(c) Buffer memory 2098 (832H) to 2110 (83EH)

The following informations are stored in this area:

- Device related trouble information  
This area stores the slave station inherent self-diagnostic information that is not set by the PROFIBUS-DP standards.
- Identifier related trouble information  
For module type slave stations, whether or not a module error has occurred is stored as bit information.
- Channel related trouble information  
For module type slave station, this stores the, error information of all modules outputting an error.

1) Device Related trouble information

This stores the slave module inherent trouble information that is not set by the PROFIBUS-DP standards. The device related trouble can be divided by header and trouble information. This area stores a 2 bit value that is the device related trouble information in the header, including the header (1 byte), and the device related trouble information for this area.

Buffer memory address decimal (Hexadecimal)		
2098 (832H)	(2nd byte)	Header (1st byte)
2099 (833H)	(4th byte)	(3rd byte)
		.....

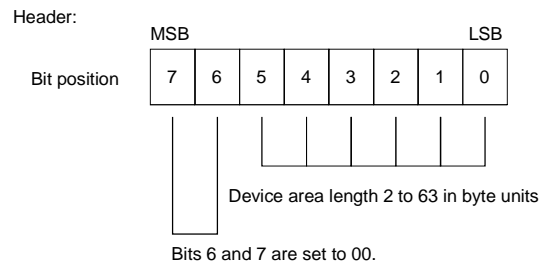

2) Identifier related trouble information

For module type slave stations, this stores as bit information whether or not a module is outputting an error. The identifier related trouble information can be divided into header and trouble information. This area stores a 2 bit value that is the identifier related trouble information in the header, including the header (1 byte), and the device related trouble information for this area.

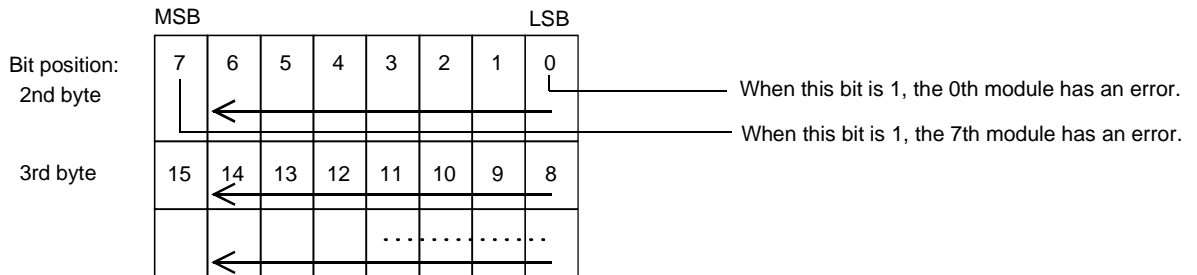
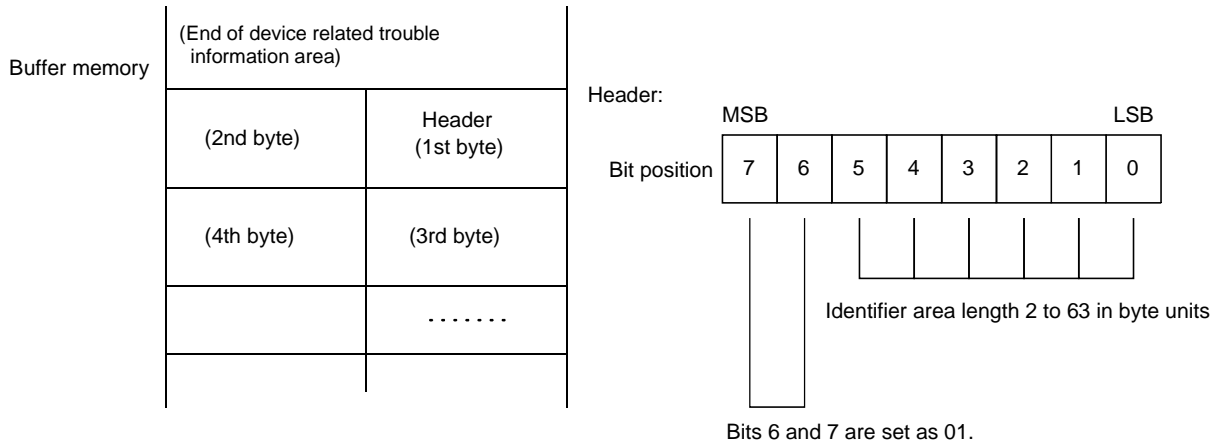

3) Channel related trouble information

When a module type slave station, this area stores the trouble information for each module that is outputting an error. This area does not have a header and stores this information at the end of the identifier related trouble information. Each channel trouble information consists of an identifier No., channel No., and error type of 3 bytes.

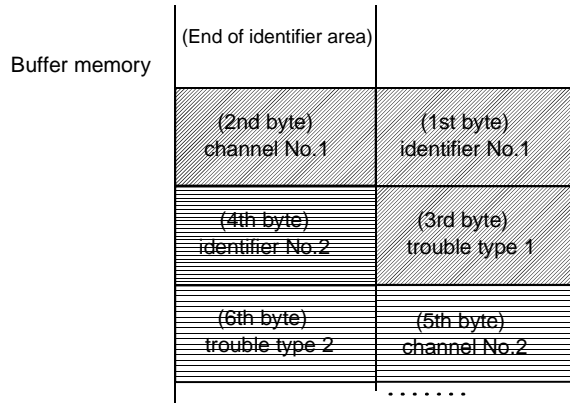

1st byte: Identifier No.

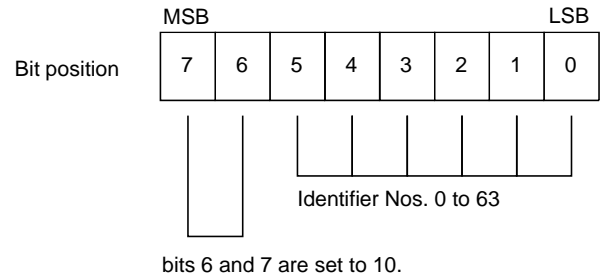

2nd byte: Channel No.

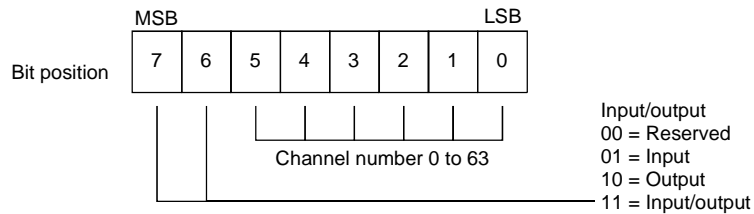

3rd byte: Trouble type

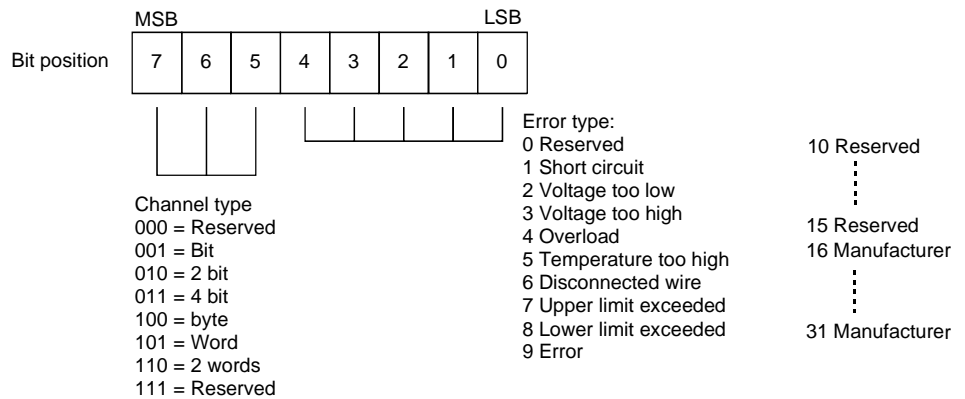

4) Identifier No., channel No.

The slave identifier No. and channel No. are discussed below.

The identifier No. is the No. that is attached from the header of each slave module.

Each module can have multiple channels.

Refer to the each slave specifications regarding to the channel numbering method.

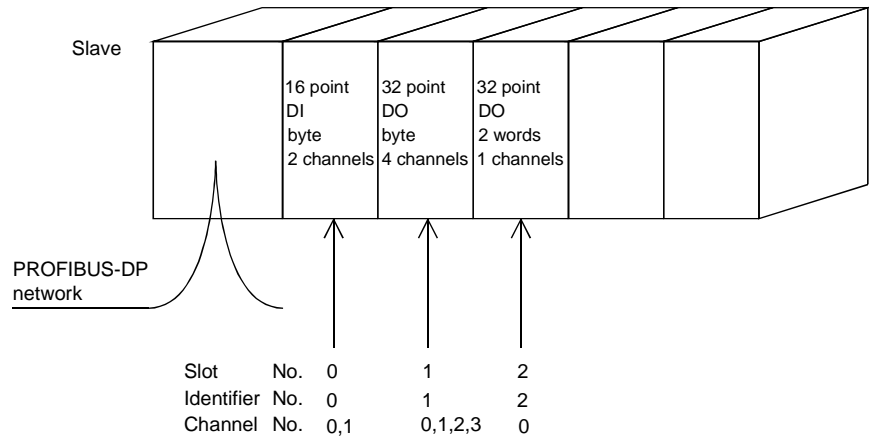

(d) Example expansion communication trouble area

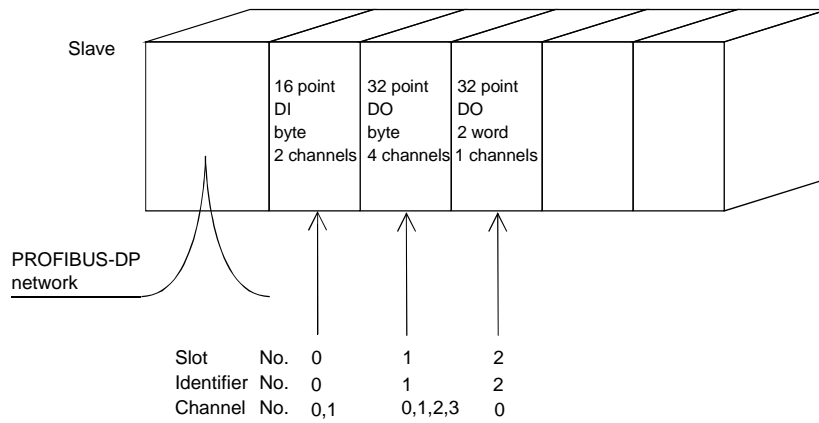
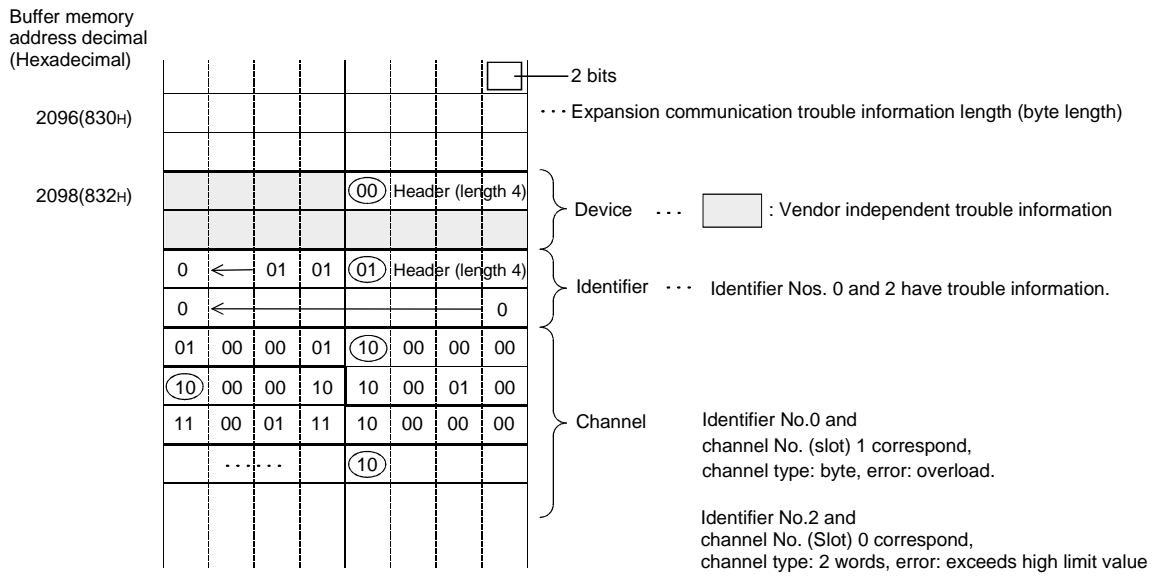



(6) Slave trouble information cancel area (Un\G2080)

Setting some values to this area can mask (invalidate) any data of the trouble information that is sent from a slave station during communication. (Initial value: 02B9H)

0: Validates the trouble information.

1: Invalidates the trouble information.

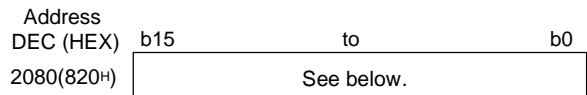

bit	Description	Initial value
b0	Parameter transmission request from a slave station.	1
b1	Trouble information read request.	0
b2	Fixed to 0.	0
b3	The slave station is monitored by the watchdog timer.	1
b4	Slave station entered FREEZE mode.	1
b5	Slave station entered SYNC mode.	1
b6	0 (Reserved).	0
b7	Excluded from I/O data exchange according to the parameter settings.	1
b8	Unable to exchange I/O data with slave station.	0
b9	The slave station is not ready to exchange I/O data.	1
b10	The parameter (No. of I/O bytes) received from the master station does not match that of the slave station.	0
b11	Expansion communication trouble information exists.	0
b12	The function requested by the master station is not supported.	0
b13	Illegal response from slave station.	0
b14	Illegal parameter(s) sent from the master station.	0
b15	Controlled by another master station.	0

Even if trouble information corresponding to each bit is generated on a slave station, it is not recognized as trouble information, and the status of the QJ71PB92D is as follows:

- The communication trouble detection signal (X01) does not turn ON.
- The RSP ERR. LED does not turn ON.
- No error code and detailed data is stored in the communication trouble area (Un\G2040 to Un\G2079) and/or expansion communication trouble area (Un\G2096 to Un\G2110).
- The bit corresponding to the station that sent the trouble information does not turn ON in the Slave status area (Un\G2112 to Un\G2116).

<b>POINT</b>	Set values into the slave error information cancel area when the exchange start request signal (Y00) is OFF. Values set with the exchange start request signal (Y00) ON are ignored.
--------------	---

(7) Global control area (Un\G2081)

- (a) Set the global control function to be executed.

Specify the global control service to be sent by bits b5 to b2 in the Global control area, and set the target group No. by bits b15 to b8. (Initial value: 0000H)

0: Not execute

1: Execute

Address DEC(HEX)	b15	to	b0
2081(821H)	See below.		

bit	Description	Initial value	Reference Section
b0	Unused (Fixed to 0)	0	—
b1	Unused (Fixed to 0)	0	Refer to (b)
b2	UNFREEZE (Retention of the actual input data is disabled.)	0	
b3	FREEZE (Actual input data is held and read.)	0	
b4	UNSYNC (Retention of the actual input data is disabled.)	0	
b5	SYNC (Actual output data is written and held.)	0	
b6	Unused (Fixed to 0)	0	—
b7	Unused (Fixed to 0)	0	Refer to (c)
b8	Executed on slave stations in group 1	0	
b9	Executed on slave stations in group 2	0	
b10	Executed on slave stations in group 3	0	
b11	Executed on slave stations in group 4	0	
b12	Executed on slave stations in group 5	0	
b13	Executed on slave stations in group 6	0	
b14	Executed on slave stations in group 7	0	
b15	Executed on slave stations in group 8	0	

(b) Setting global control services (b5 to b2)

The following service combinations are not executable at the same time.

- SYNC and UNSYNC (If both services are attempted concurrently, UNSYNC only is enabled.)
- FREEZE and UNFREEZE (If both services are attempted concurrently, UNFREEZE only is enabled.)

The following shows the services and their set values for b5 to b2.

1) Setting for execution of the SYNC and UNSYNC services

Service to be Executed	Set Value	
	b5	b4
SYNC	1	0
UNSYNC	0*1	1

\*1 When 1 is set to this bit, it is handled as an invalid value. (The operation is the same as when the value is set to 0.)

2) Setting for execution of the FREEZE and UNFREEZE services

Service to be Executed	Set Value	
	b3	b2
FREEZE	1	0
UNFREEZE	0*1	1

\*1 When 1 is set to this bit, it is handled as an invalid value. (The operation is the same as when the value is set to 0.)

(c) Setting the target group No. (b15 to b8)

Multiple group Nos. can be set for the target group No.

When 0s are set to all of b8 to b15, the set global control service is sent to all slave stations (including slave stations for which group No. is not set).

**REMARK**

For details on the global control, refer to Section 4.1.2.

(8) Trouble no information time setting area (Un\G2084)

The time during which no trouble information is notified after communication start (after exchange start end signal (X00) turns ON) is set in this area. (Initial value: 20 seconds)

Set Value	Description
0 to 65535	Set the time during which trouble information is not notified. (Unit: seconds)

This setting prevents temporary error detection. (e.g. when turning ON a slave station after turning ON the QJ71PB92D)

When trouble information is generated within the time duration set by this setting, the conditions are as follows:

- The communication trouble detection signal (X01) does not turn ON.
- The RSP ERR. LED does not turn ON.
- No error code and detailed data is stored in the communication trouble area (Un\G2040 to Un\G2079) and/or expansion communication trouble area (Un\G2096 to Un\G2110).
- The bit corresponding to the station that sent the trouble information does not turn ON in the Slave status area (Un\G2112 to Un\G2116).

POINT
Set a value into the trouble no information time setting area when the exchange start request signal (Y00) is OFF. Values set with the exchange start request signal (Y00) ON are ignored.

(9) Slave status area (Un\G2112 to Un\G2116)

This is the area that stores the status of each slave station.

The following figure shows the configuration:

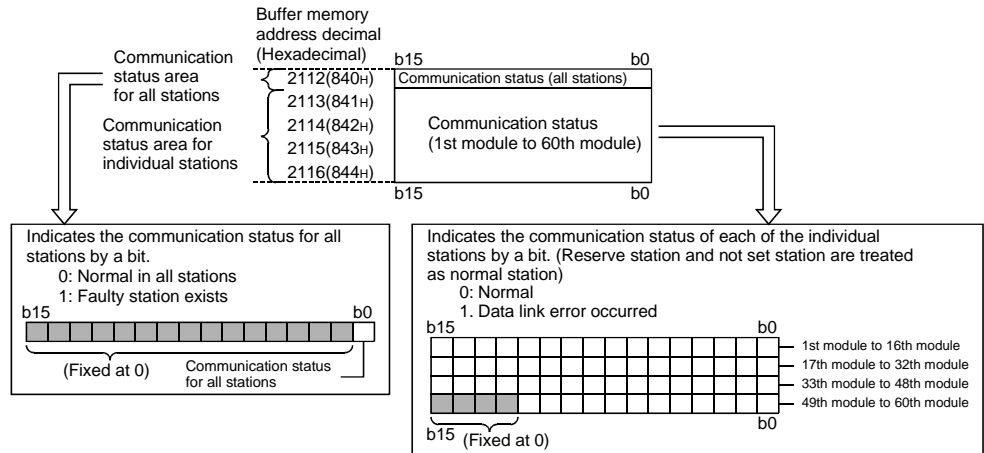

- The communication status of each slave station under communication is set up.
- This area is operated when either the normal service mode (MODE 0) or extended service mode (MODE E) is set up.

**POINT**

- (1) Data are assigned to the slave station area in the order of GX Configurator-DP parameter settings (in the order of station numbers).  
The actual assignment order can be confirmed in the Address information area (Un\G1920 to Un\G2039) or in Slave List of GX Configurator-DP.

Slave List						
Index	FDL Addr	Link Status	Input Addr.	Input Size	Output Addr.	Output Size
1	3	Link	0	28	960	28
2	10	Link	14	20	974	0
3	32	No Link	24	14	974	14

Order of assignment →

Last known CPU Error	
No Error	

- (2) The buffer memory is reassigned if parameters are modified (deletion or addition of some slave stations) in GX Configurator-DP.  
Check the sequence program after modifying the parameters.  
If there are slave stations to be connected in the future, set them as reserved stations in the parameter setting.  
Doing so eliminates the need to check the sequence program.

(10) Input/Output start address area (Extended service mode (MODE E) only)  
(Un\G2128 to Un\G2247)

When the operation mode is extended service mode (MODE E), the start address (buffer memory address) for each slave station I/O data is stored in this area.

Creating a sequence program using this area allows address specification for the input and output areas without considering the number of I/O points for each slave station. (Refer to Section 7.3.)

In the normal service mode (MODE 0), 0s are stored in all areas.

(a) Configuration of I/O start address area

In this area, input data and output data of 60 stations are stored in the same order.

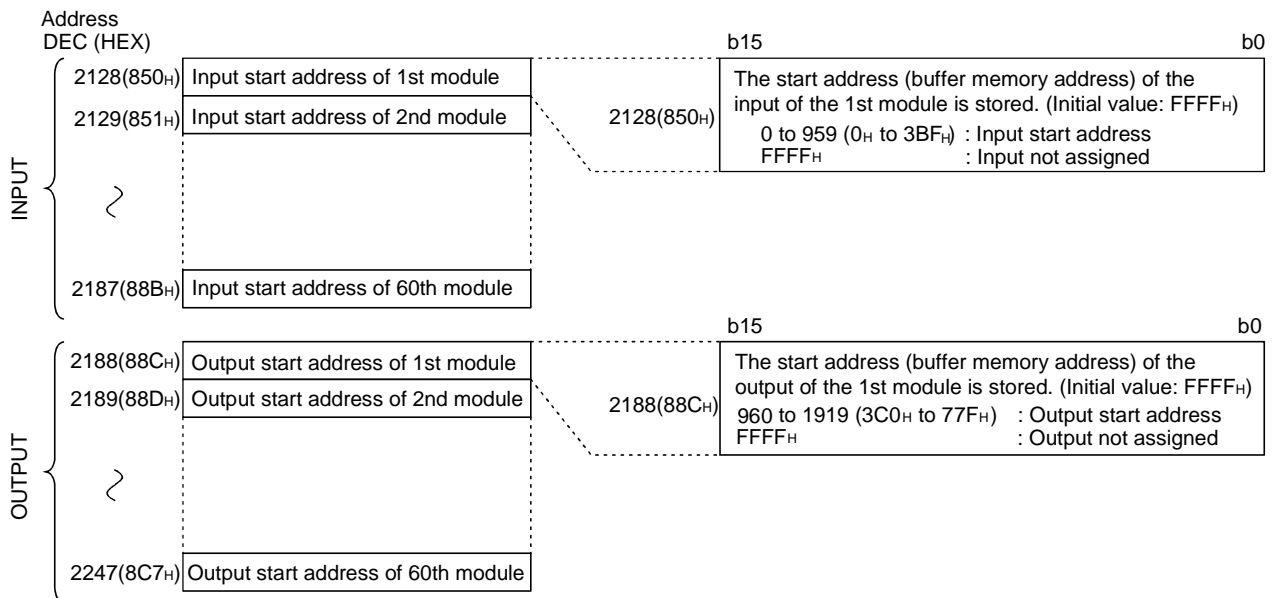

(b) Setup timing

The input start address and the output start address are stored when the module is started up.

(c) Start address

The start address is set in 1 word units for both input and output.

The start address are stored in the input area or output area, starting from the head.

**POINT**

- (1) Data are assigned to the I/O start address areas in the order of GX Configurator-DP parameter settings (in the order of station numbers). The actual assignment order can be confirmed in the Address information area (Un\G1920 to Un\G2039) or in Slave List of GX Configurator-DP.

Order of assignment →

Slave List						
Index	FDL Addr	Link Status	Input Addr.	Input Size	Output Addr.	Output Size
1	3	Link	0	28	960	28
2	10	Link	14	20	974	0
3	32	No Link	24	14	974	14
Last known CPU Error						
No Error						

- (2) The buffer memory is reassigned if parameters are modified (deletion or addition of some slave stations) in GX Configurator-DP. Check the sequence program after modifying the parameters. If there are slave stations to be connected in the future, set them as reserved stations in the parameter setting. Doing so eliminates the need to check the sequence program.

(d) Example

The following shows an example of assignment in the input and output areas, together with values that are stored in the I/O start address area as a result of the example assignment.

1) Assignment in the input and output areas

Input area

0(0H)	1st module 2nd input byte	1st module 1st input byte
1(1H)		1st module 3rd input byte
2(2H)	2nd module 2nd input byte	2nd module 1st input byte
3(3H)	2nd module 4th input byte	2nd module 3rd input byte
4(4H)	2nd module 6th input byte	2nd module 5th input byte
5(5H)		2nd module 7th input byte

Output area

960 (3C0H)	1st module 2nd output byte	1st module 1st output byte
961 (3C1H)	1st module 4th output byte	1st module 3rd output byte
962 (3C2H)		1st module 5th output byte
963 (3C3H)	2nd module 2nd output byte	2nd module 1st output byte
964 (3C4H)		2nd module 3rd output byte

2) Resulting values stored in the I/O start address area

Address DEC(HEX)		Values stored
2128(850H)	Input start address for 1st module	• • • 0(0H)
2129(851H)	Input start address for 2nd module	• • • 2(2H)
2188(88CH)	Output start address for 1st module	• • • 960(3C0H)
2189(88DH)	Output start address for 2nd module	• • • 963(3C3H)

**REMARK**

For a program example that uses the I/O start address area, refer to Section 7.3.



## (11) Current operation mode area (Un\G2254)

This area stores the current operation mode value.

Stored Value	Description
0000H	Normal service mode (MODE 0)
0001H	Parameter setting mode (MODE 1)
0002H	Self-diagnosis mode (MODE 2)
0009H	Flash ROM initialization mode
000EH	Extended service mode (MODE E)
0100H	Normal service mode (MODE 0)* <sup>1</sup>
0101H	Parameter setting mode (MODE 1)* <sup>1</sup>
010EH	Extended service mode (MODE E)* <sup>1</sup>

\*1 Operation mode currently stored to flash ROM.

**REMARK**

For details on operation mode, refer to Section 4.2.

## (12) Operation mode change request area (Un\G2255)

For execution of the operation mode change request, set a desired operation mode. (Initial value: FFFE<sub>H</sub>)

The initial value (FFFE<sub>H</sub>) is used for malfunction prevention.

If the Operation mode change request signal (Y11) is turned ON with the initial value stored in the Operation mode change request area, 0001<sub>H</sub> is stored in the Operation mode change result area (Un\G2256) and the operation mode is not changed.

Setting value	Description
0000H	The mode is changed to normal service mode (MODE 0).
0001H	The mode is changed to parameter setting mode (MODE 1).
0002H	The mode is changed to self-diagnosis mode (MODE 2).
0009H	The mode is changed to flash ROM initialization mode.
000EH	The mode is changed to extended service mode (MODE E).
0100H	The mode is changed to normal service mode (MODE 0). The normal service mode (MODE 0) is registered to the flash ROM at the same time as the operation mode change.
0101H	The mode is changed to parameter setting mode (MODE 1). The parameter setting mode (MODE 1) is registered to the flash ROM at the same time as the operation mode change.
010EH	The mode is changed to extended service mode (MODE E). The parameter setting mode (MODE 1) is registered to the flash ROM at the same time as the operation mode change.
FFFFH	The mode is changed to parameter setting mode (MODE 1). The mode registered to the flash ROM is deleted at the same time as the operation mode change.

**REMARK**

For details on operation mode, refer to Section 4.2.

**(13) Operation mode change result area (Un\G2256)**

This area stores the execution result of the operation mode change request.

0: Normal completion.

1: Abnormal completion. (A mode change request of the unauthorized value was given.)

On abnormal completion, the QJ71PB92D does not change the operation mode. It maintains the same operation mode as before the change request was given.

**(14) Local station number display area (Un\G2257)**

Used to store the number of the local station.

The storage area is 0 to 125.

**(15) Self-diagnosis status code area (Un\G2258)**

The self-diagnosis test details or test result is stored in this area.

For details on the self-diagnosis test, refer to Section 5.4.

## 4. FUNCTIONS

### 4.1 Functions for Exchanging with Slaves

#### 4.1.1 I/O data exchange

The QJ71PB92D can operate as a class 1 master station on the PROFIBUS-DP system and perform I/O data exchange with slave stations.

Up to 60 slave stations can be connected to a single QJ71PB92D, enabling the exchange of I/O data up to 3840 bytes (Input data: Max. 1920 bytes, Output data: Max.1920 bytes).

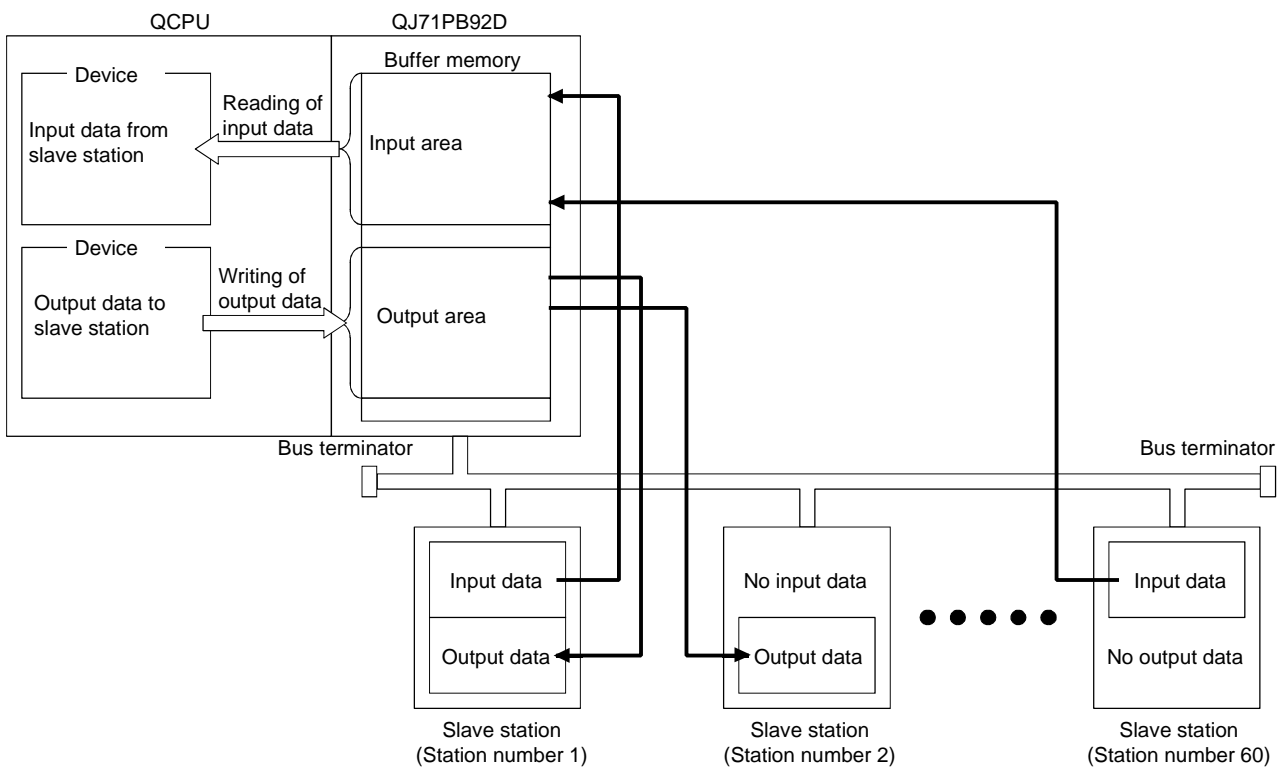

4

#### (1) Reading/writing I/O data

##### (a) Buffer memory

Read or write I/O data from the following buffer memory in the QJ71PB92D:

- Input data: Input area (Un\G0 to Un\G959)
- Output data: Output area (Un\G960 to Un\G1919)

##### (b) Read/write methods

Read or write I/O data (from the buffer memory) to devices in QCPU by the following methods.

Read/Write Methods	Setting Location	Separation prevention function
Automatic refresh	GX Configurator-DP	Available
Dedicated instructions (BBLKRD, BBLKWR)	Sequence program	
MOV or FROM/TO instructions	Sequence program	Not available

(2) Starting and stopping I/O data exchange

- (a) Write the initial value of the output data to the Output area.
- (b) Turn ON the exchange start request signal (Y00).
- (c) When I/O data exchange is started after turning ON the exchange start request signal (Y00), the exchange start end signal (X00) turns ON.
- (d) Input data from slave stations are stored in the Input area.
- (e) When the exchange start request signal (Y00) is turned OFF, the exchange start end signal (X00) turns OFF, and then I/O data exchange stops.

[Output data exchange]

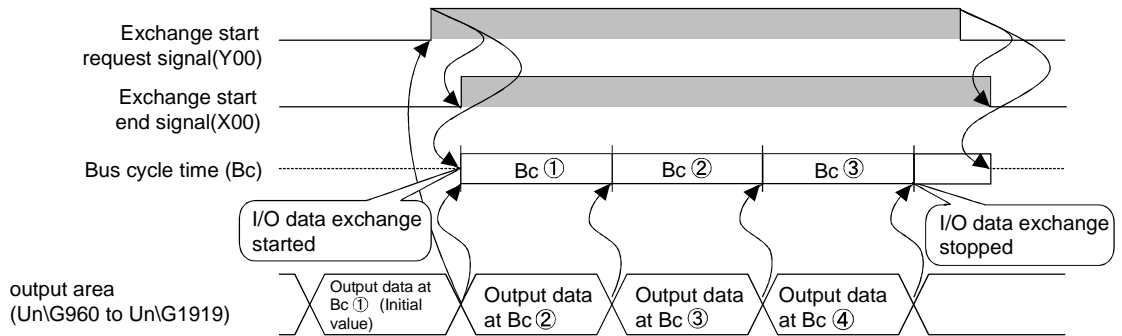

[Input data exchange]

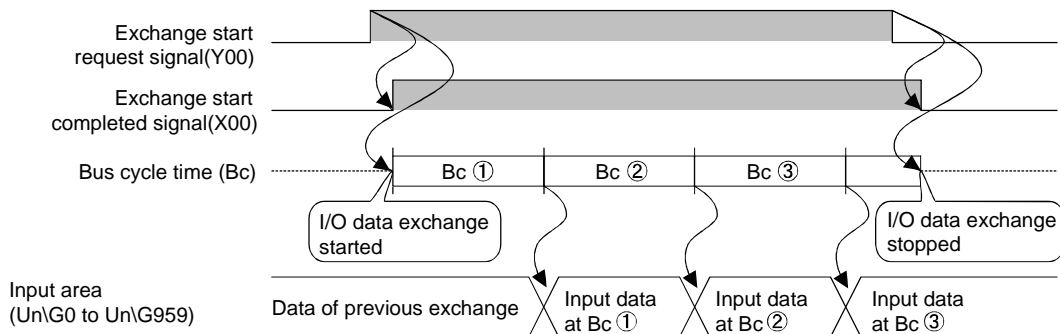

**Remark**

For program examples for the I/O data exchange function, refer to Sections 7.1 to 7.4.

4.1.2 Global control functions

By multicasting (broadcasting) data, the QJ71PB92D can simultaneously control I/O data of each slave station in a specified group.

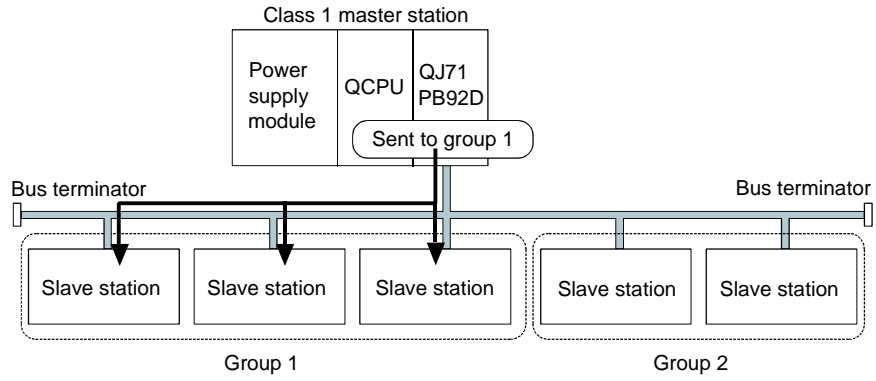

(1) Global control services

(a) SYNC, UNSYNC

1) SYNC

This service starts the SYNC (output synchronization) mode.  
 In the SYNC mode, the output status is refreshed every time a slave station receives the SYNC service.  
 If no SYNC service is received, the output status is held.

2) UNSYNC

This service ends the SYNC (output synchronization) mode.

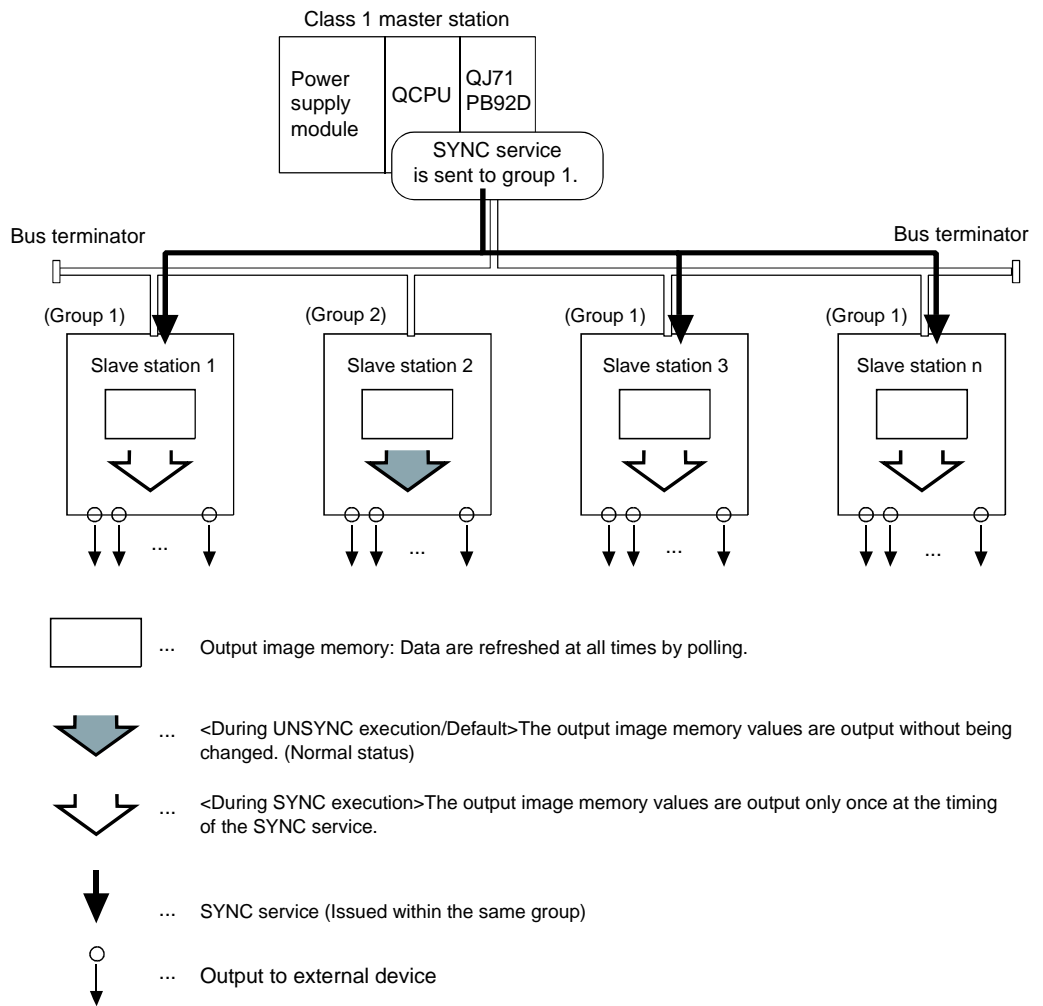

(b) FREEZE, UNFREEZE

1) FREEZE





This service starts the FREEZE (input synchronization) mode.  
 In the FREEZE mode, the input status is refreshed every time a slave station receives the FREEZE service.

If no FREEZE service is received, the input status is held.

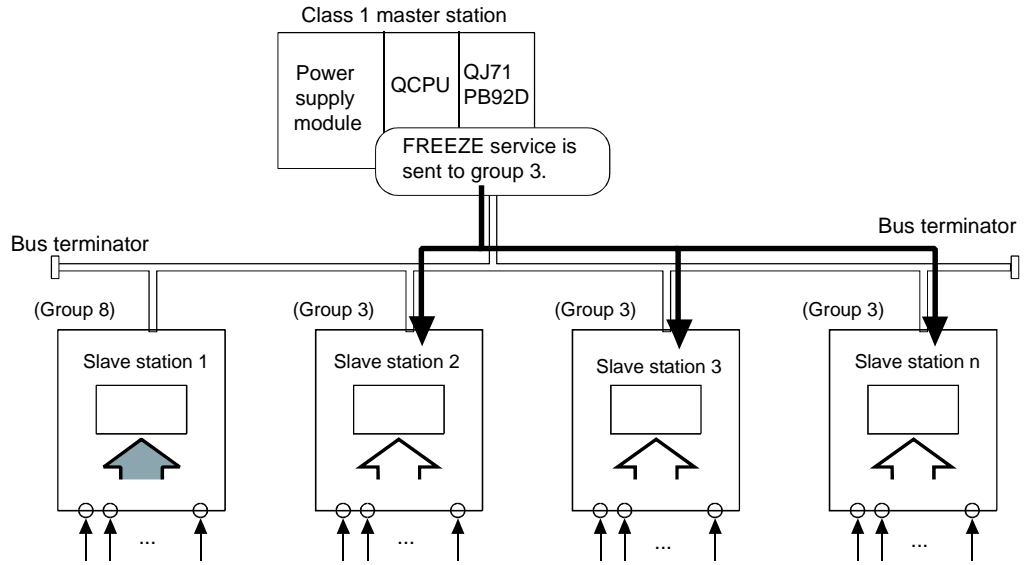
2) UNFREEZE

This service ends the FREEZE (input synchronization) mode.



-  ... Input image memory: Data are refreshed at all times by polling.
-  ... <During UNFREEZE execution/Default>Actual input data are input to the input memory without being changed. (Normal status)
-  ... <During FREEZE execution>Actual input data are input only once to the input image memory at the timing of the FREEZE service.
-  ... FREEZE service (Issued within the same group)
-  ... Input from external device

## (2) Group setting

The group setting can be made with the slave parameters ("Slave Parameter Settings" in GX Configurator-DP).

Up to eight groups, groups 1 to 8, can be set.

Multiple groups can also be assigned to a single slave station.

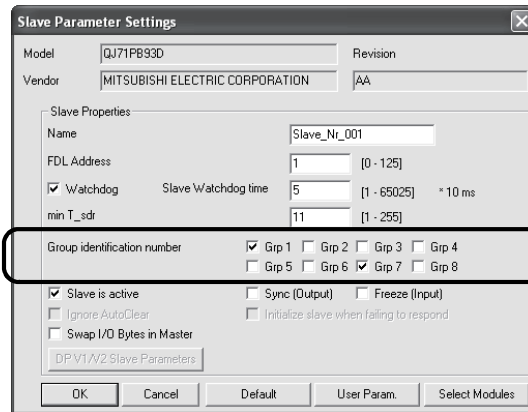

## (3) Executing the global control function

Execute the global control function by the following procedure:

- (a) Write the service to be sent and the target group to the Global control area (Un\G2081).
- (b) Turn ON the Global control request signal (Y04).
- (c) When global control processing is completed, the Global control end signal (X04) turns ON.  
If the processing failed, the Global control error end signal (X05) turns ON.
- (d) After confirming completion of the global control, turn OFF the Global control request signal (Y04).

**POINT**

To execute the global control function to all slave station (including slave station for which group No. is not set), set 0s to all of b15 to b8 in the Global control area (Un\G2081).

**REMARK**

For a program example for global control function, refer to Section 7.5.



4.1.3 Word data swap function

This function swaps the upper and lower bytes in word units when I/O data is sent and received.

Use this function for slave stations whose word structure is different (upper and lower bytes are reversed) from that of the QJ71PB92D.

This function enables you to swap upper and lower bytes to exchange I/O data without the need to create a special sequence program for the swapping.

(1) Data swap setting

The data swap setting can be made with the slave parameters ("Slave Parameter Settings" in GX Configurator-DP).

Data swap setting must be made for each slave station.

Mark the Swap I/O Bytes in Master checkbox to enable the swap setting for the slave station.

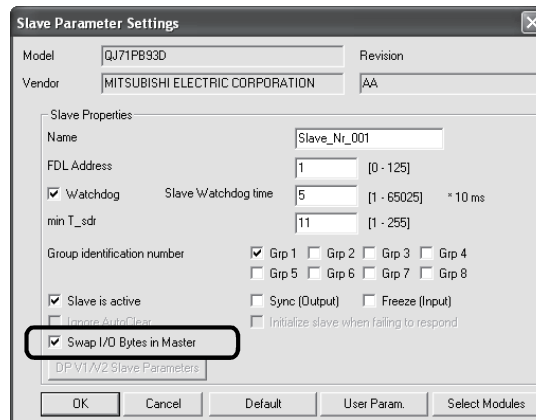

(2) Swap

The following shows a standard setting example of the swap function and a data transfer example.

(a) Standard swap function setting for each slave station type

Classification by slave station	Swap function setting
Byte (I/O) data only	Not swapped
Word data only	Swapped
Mixture of byte (I/O) data and word data	Not swapped (Only for word data, swapped using the sequence program)

(b) Example of data transmission

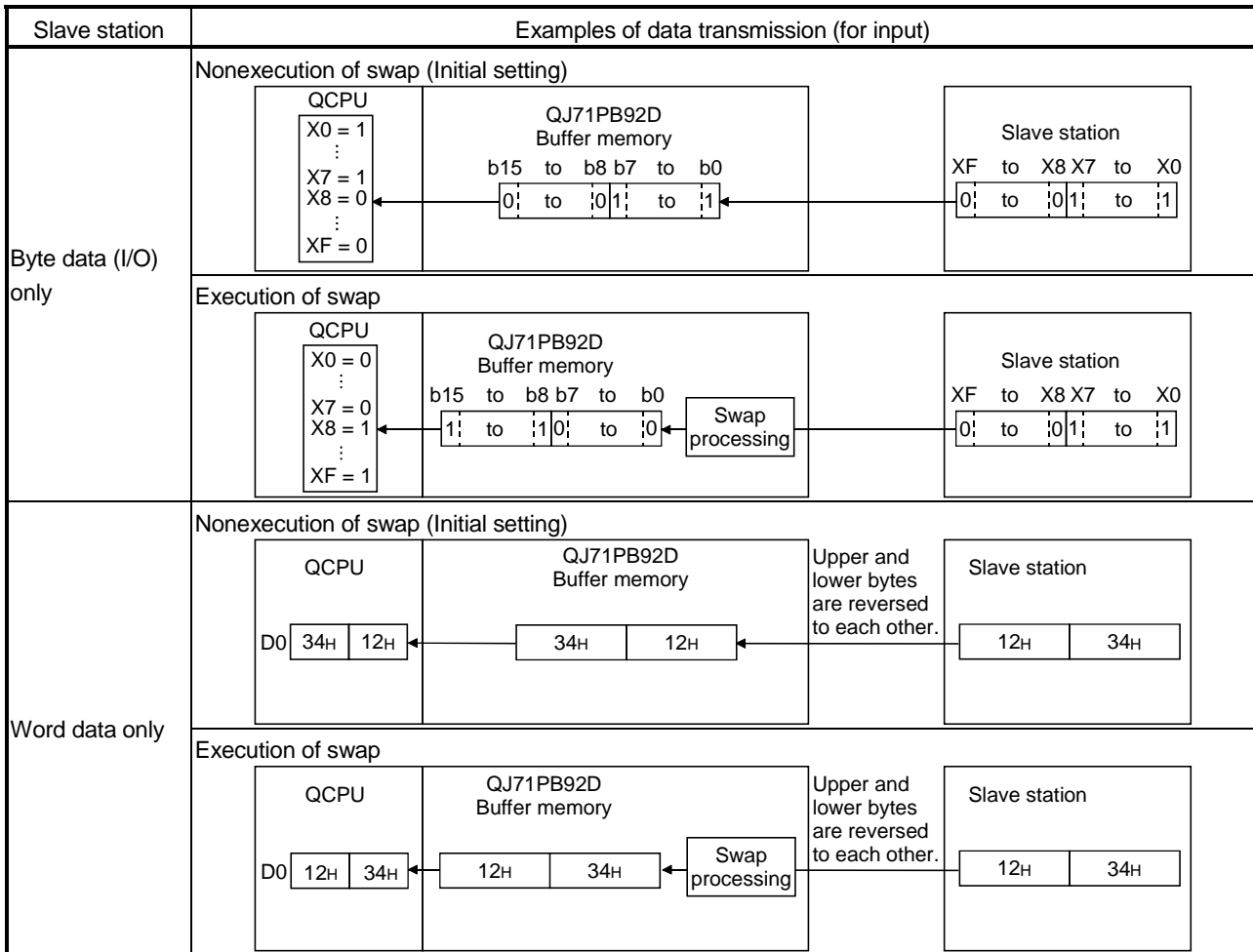

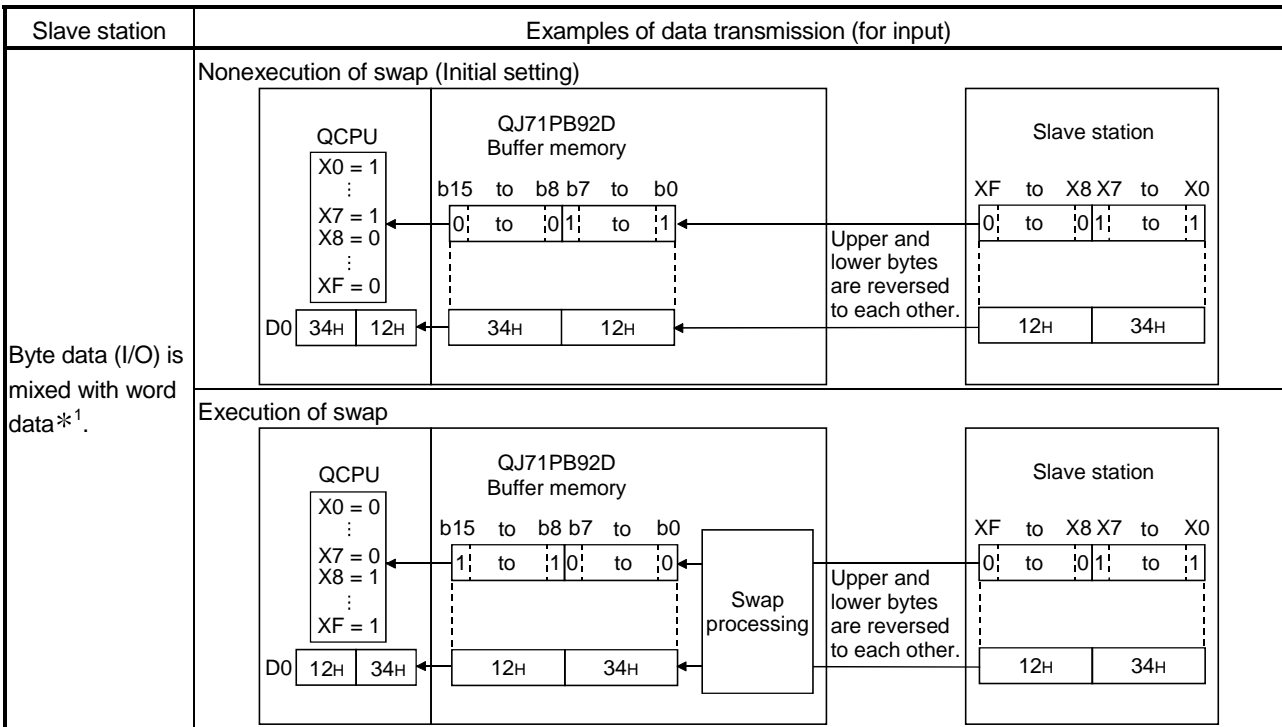

\*1 For a slave station where byte data (I/O) is mixed with word data, it is recommended to swap-process only the word data using the sequence program without executing the swap function.

4.1.4 I/O data separation prevention function

When I/O data from slave stations are read from or written to buffer memory, this function prevents the I/O data from being separated and incorrectly mixed.

(1) I/O data separation prevention function

(a) The PROFIBUS-DP bus cycle and QCPU sequence scan are performed asynchronously.

Because of this, when the QCPU reads input data in the buffer memory during input data transfer from a slave station to the buffer memory, the original data may be divided generating inconsistency in the input data. (The same applies to output data.)

The following shows an example of separation of input data.

<Before the data separation prevention function is used>

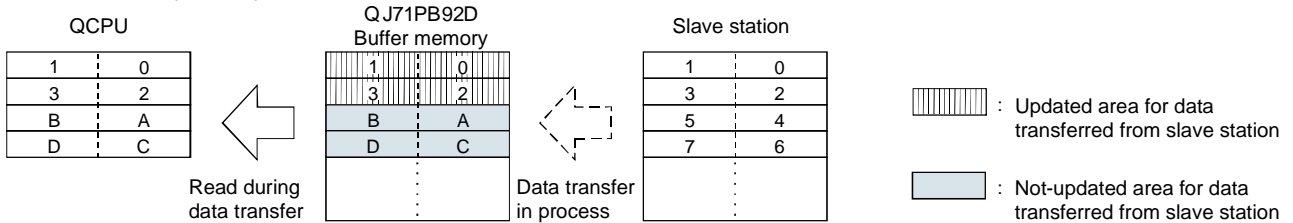

(b) When the separation prevention function is used, the reading from the QCPU is waited during the data transmission from the slave station to the buffer memory (input area) of QJ71PB92D, and executed after the data transmission has been completed.

Also, the data transmission to the slave station is waited until the writing from the QCPU to the buffer memory (output area) of QJ71PB92D is completed, and executed after the writing has been completed.

<After the data separation prevention function is used >

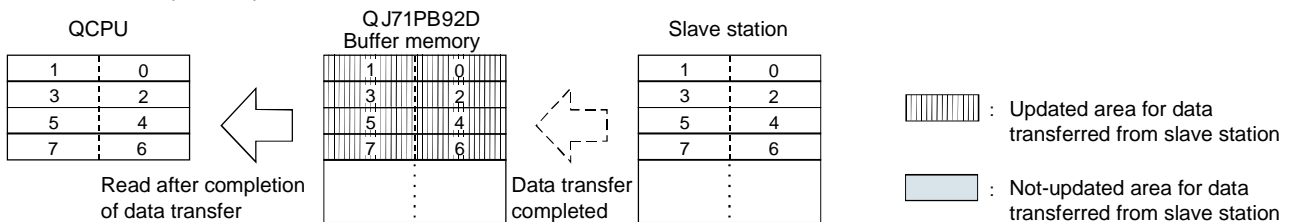

(2) How to prevent data inconsistency

The I/O data separation prevention function is executed by either of the following methods.

This function is not available when the MOV or FROM/TO instruction is used for buffer memory reading/writing.

(a) Using automatic refresh

In GX Configurator-DP, select [Setup] → [PLC and GX IEC Developer (GID) Settings] and enable the automatic refresh setting.

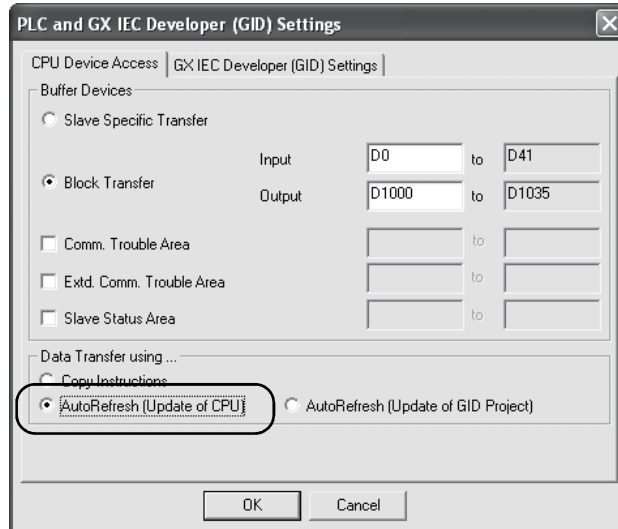

To use the data separation prevention function by automatic refresh, check the checkbox of the master parameter, Consistency.

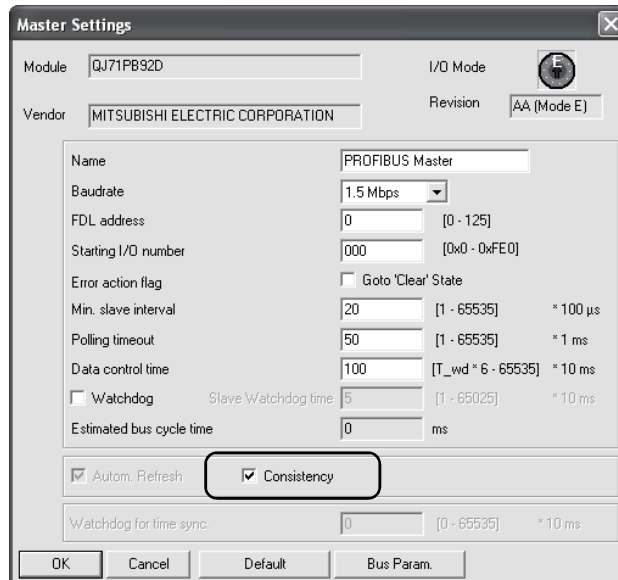

**REMARK**

For the automatic refresh setting method, refer to Section 5.1.5.

- (b) Using dedicated instruction  
Using the BBLKRD or BBLKWR instruction to read or write data prevents I/O data separation. (Refer to Chapter 8.)

**REMARK**

Refer to Section 7.4 for program examples of the I/O data communication using dedicated instructions.

**(3) Precautions**

- (a) Applicable CPU module  
To utilize the separation prevention function, use a QCPU whose first five digits of the serial No. is 02092 or later. (Refer to Section 2.4.)
- (b) Transmission delay time caused by the separation prevention function  
The delay time in transmission between the QCPU and slave is lengthened because the QJ71PB92D have to wait for reading from or writing to the QCPU and data transfer from/to the master station. (Refer to Section 6.2.)  
The separation prevention function can be disabled in the automatic refresh setting.  
Disable the separation prevention function when it is not necessary.
- (c) When the separation prevention function is enabled in the automatic refresh setting  
Dedicated instructions are not executable. (They are not processed.)  
They can be executed when the separation prevention function is disabled in the automatic refresh setting.

## 4.2 Operation Mode

This section describes QJ71PB92D operation modes and the procedure for setting the operation mode.

The operation mode of the QJ71PB92D can be changed by using the Operation mode change request area (Un\G2255) or on the GX Configurator-DP.

### (1) Types of operation modes

The following lists the operation modes of the QJ71PB92D.

Operation mode	Description	Operation mode change		Reference
		Operation mode change request area (Un\G2255)	GX Configurator-DP	
Normal service mode (MODE 0)	I/O data exchange with slave stations is performed in this mode. The I/O area assigned to each slave station has a fixed capacity of 32 bytes.	○	○	Section 4.2.1
Extended service mode (MODE E)	I/O data exchange with slave stations is performed in this mode. The I/O area for each slave station is assigned based on the variable data length (in byte units) for each station. The data length (in byte units) for each station is set as a slave parameter (Slave Modules) in GX Configurator-DP.	○	○	Section 4.2.2
Parameter setting mode (MODE 1)	The parameters set on GX Configurator-DP are written to QJ71PB92D in this mode. When no operation mode has been written to the flash ROM, the QJ71PB92D starts up in this mode.	○	○	—
Self-diagnosis mode (MODE 2)	The unit test on the QJ71PB92D is performed in this mode.	○	×	Section 5.4
Flash ROM initialization mode	This mode is used to return the QJ71PB92D to the factory default status.	○	○	Section 9.5

○ : Changeable, × : Not changeable

### (2) Changing the operation mode by the Operation mode change request area (Un\G2255)

Perform the following procedure when changing the operation mode from the Operation mode change request area (Un\G2255).

- (a) Write a value for a desired operation mode into the Operation mode change request area (Un\G2255) (Refer to Section 3.4.2(12)).
- (b) Turn ON the Operation mode change request signal (Y11).
- (c) The Operation mode change completion signal (X11) turns ON when the operation mode is changed, and the result of the change is stored in the Operation mode change result area (Un\G2256).
- (d) Make sure that 0<sub>H</sub> (Normally completed) is stored in the Operation mode change result area (Un\G2256), and turn OFF the Operation mode change request signal (Y11).
- (e) Turning OFF the Operation mode change request signal Operation mode change completion signal (X11).

- (3) **Changing the operation mode by GX Configurator-DP**  
Change the operation mode at "Module Configuration" in GX Configurator-DP.  
For details, refer to the GX Configurator-DP Operating Manual.
- (4) **Storage value for the operation mode change failure**  
If the operation mode change is unsuccessfully completed, an 1H (Abnormally completed) is stored in the Operation mode change result area (Un\G2256) on the QJ71PB92D.
- (5) **Precautions when changing the operation mode**  
When the operation mode change is attempted during I/O data exchange, the QJ71PB92D stops I/O data exchange before changing the operation mode.  
The exchange start end signal (X00) turns OFF.



4.2.1 Normal service mode (MODE 0)

The normal service mode (MODE 0) is the mode for performing I/O data exchange in the setting where a fixed capacity of 32 bytes (16 words) is assigned to each slave station in the I/O area.

Because the I/O area size of each slave station is fixed, the buffer memory address is easier to understand, and the size need not be set to the parameters for each slave station.

However, when the data size of I/O is 32 bytes or less, an empty space is produced between the areas of the slave stations, and additional number of devices is required for the batch reading/writing of the I/O area.

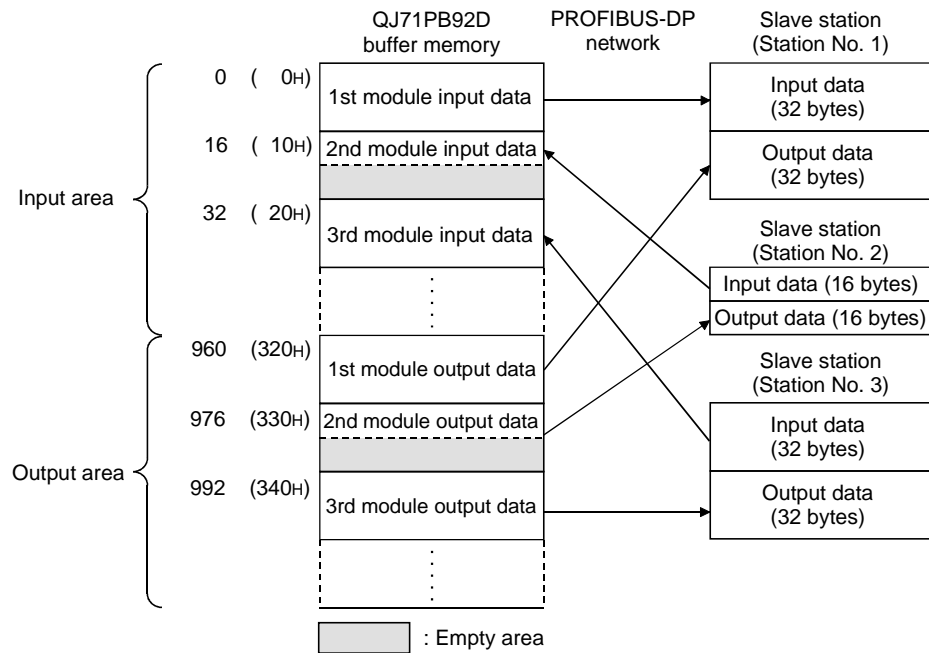

(1) Number of settable slave stations

The fixedly set number of slave stations is 60.

(2) I/O data exchange

After the exchange start end signal is turned on (X00=ON), I/O data exchange is performed with each slave station using the data stored in the I/O area.

Before the communication is started or when it is interrupted, the I/O data is not updated.

4.2.2 Extended service mode (MODE E)

In the extended service mode (MODE E), the I/O data space for each slave station is allocated within any area range to perform I/O data exchange.

Because the I/O area size can be set for each slave station, an empty space is not produced in the I/O area. (Contiguous area data can be read or written from the programmable controller CPU.)

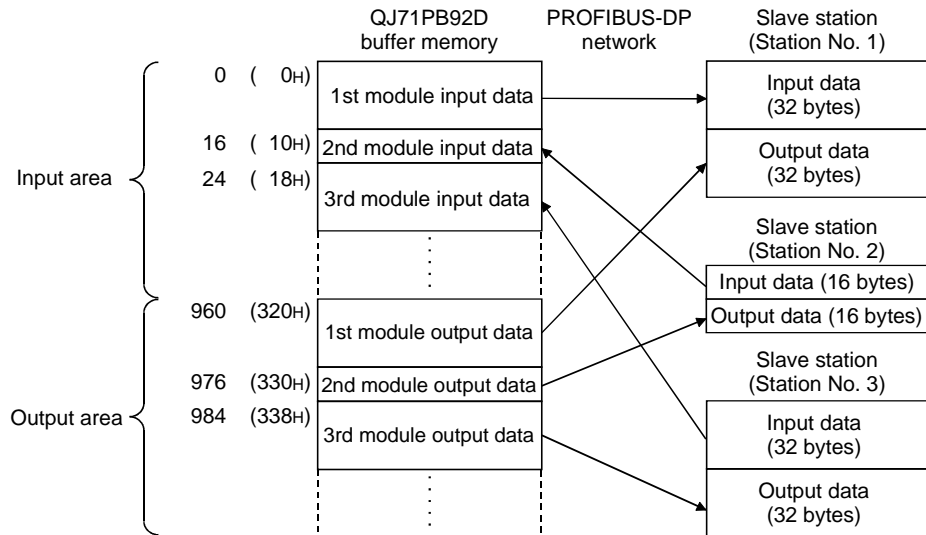

(1) Number of settable slave stations and data length

One to 60 slave stations can be set.

The length of input and output data is up to 244 bytes per slave station, and up to 1920 bytes for a total of all the slave stations.

The data length (in byte units) for each slave station is set as a slave parameter (Select Modules) in GX Configurator-DP.

When 244 bytes (max.) are allocated to each station, up to seven stations can be set up.

(2) I/O data exchange

After the exchange start end signal is turned on (X00=ON), I/O data exchange is performed with each slave station using the data stored in the I/O area.

Before the communication is started or when it is interrupted, the I/O data is not updated.

### 4.3 Output Status Setting for the Case of a CPU Stop Error

This function sets whether to continue or stop I/O data exchange with slave stations when a CPU stop error occurs on a CPU module where the QJ71PB92D is mounted.

<b>POINT</b>
When using the output status setting for the case of a CPU stop error, use the QJ71PB92D whose first 5 digits of serial No. is 06042 or later.

(1) Output status setting for the case of a CPU stop error

The output status for the case of a CPU stop error is set in the intelligent function module switch setting. (Refer to Section 5.1.6)

(2) Output status for the case of a CPU stop error

(a) When no setting (blank) is made to the switch 1 of the intelligent function module switch setting

The QJ71PB92D continues I/O data exchange when a CPU stop error occurs.

The data before occurrence of the CPU stop error are held and they are sent to the slave stations.

Input data received from slave stations updates the buffer memory of the QJ71PB92D.

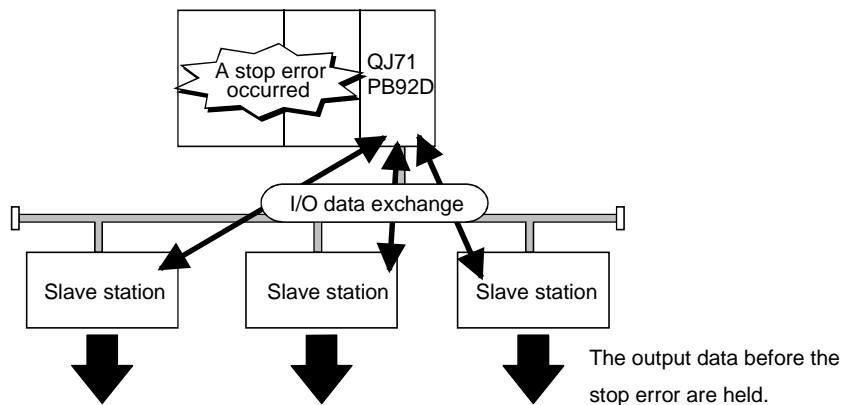

(b) When 0001<sub>H</sub> is set to the switch 1 of the intelligent function module switch setting

The QJ71PB92D stops I/O data exchange when a CPU stop error occurs. Due to stop of I/O data exchange, no output data is sent to slave stations. Input data received from a slave station before stop of I/O data exchange are held in the buffer memory of the QJ71PB92D.

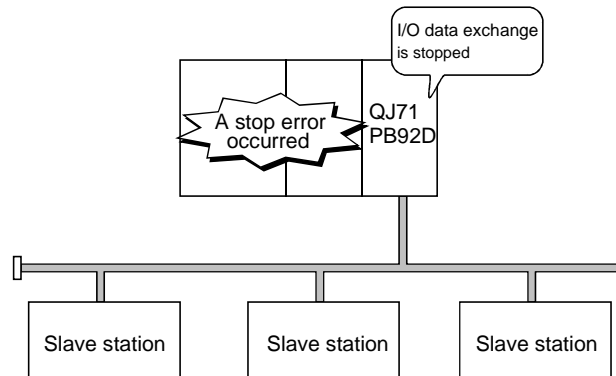

**POINT**

Whether or not output data are output from each slave station to external devices after stop of I/O data exchange differs depending on the setting of the slave station. For details, refer to the manual for the slave station.

5. PROCEDURES BEFORE SYSTEM OPERATION

5.1 Procedures before Operation

The following diagram illustrates the procedure before system operation.

QJ71PB92D

(1) For the QJ71PB92D

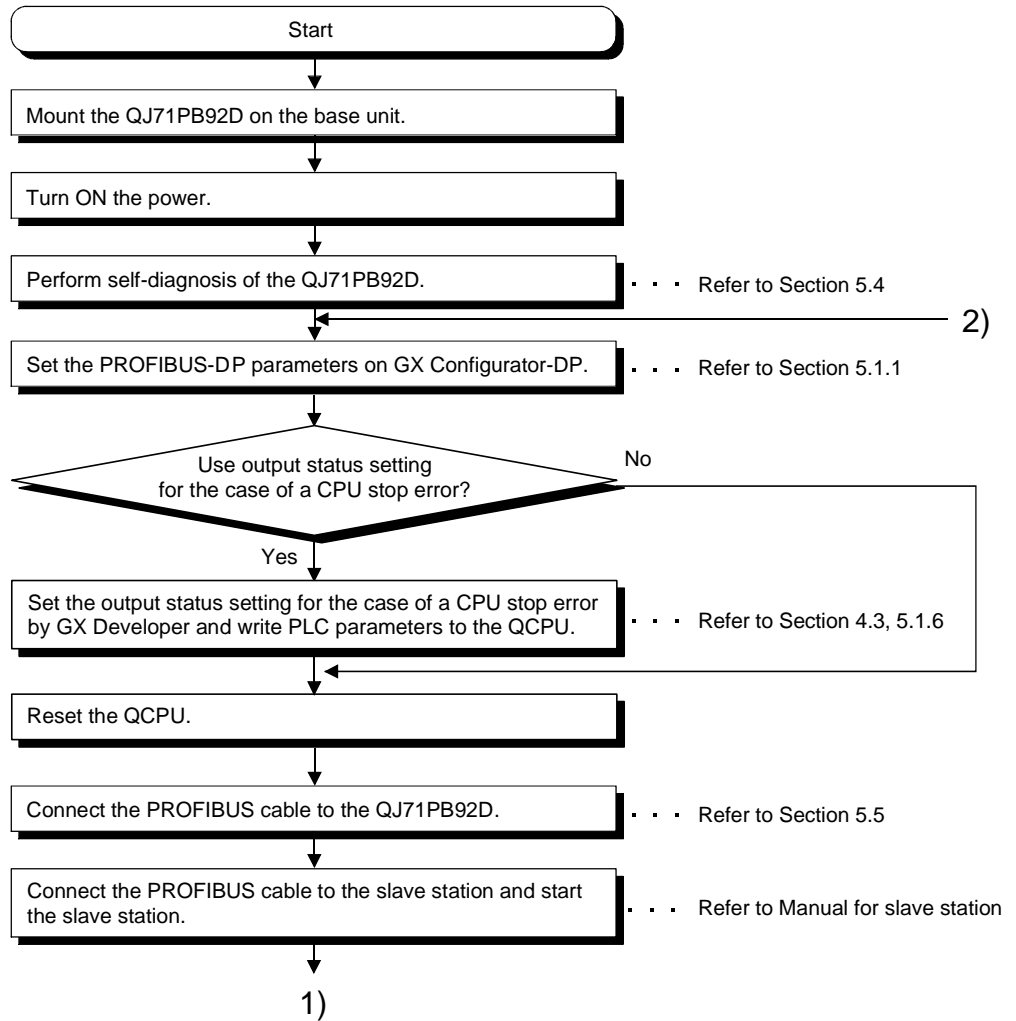

5

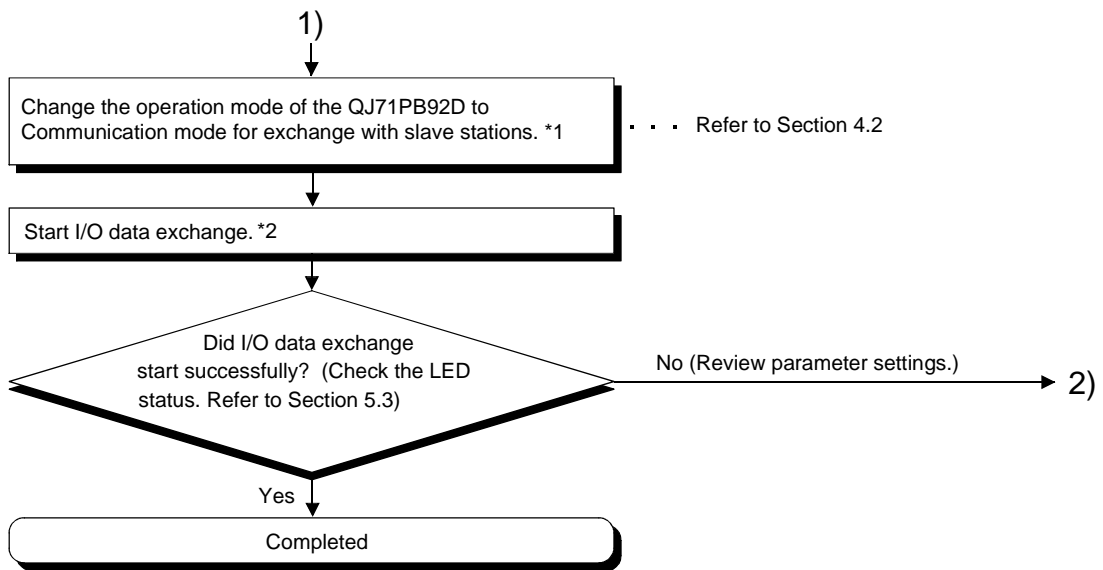

\*1 Change the operation mode by either of the following methods:

- Change it from GX Configurator-DP.
- Use the operation mode change request area (Un\G2255) and Operation mode change request signal (Y11).

\*2 Start I/O data exchange by either of the following methods:

- Turn ON the exchange start request signal (Y00).
- Start it from GX Configurator-DP.

QJ71PB92V  
(92D-compatible)

- (2) For the QJ71PB92V (QJ71PB92D-compatible function)  
In the intelligent function module switch setting of the QJ71PB92V, enable the QJ71PB92D-compatible function.  
After that, perform the same steps as those for the QJ71PB92D.

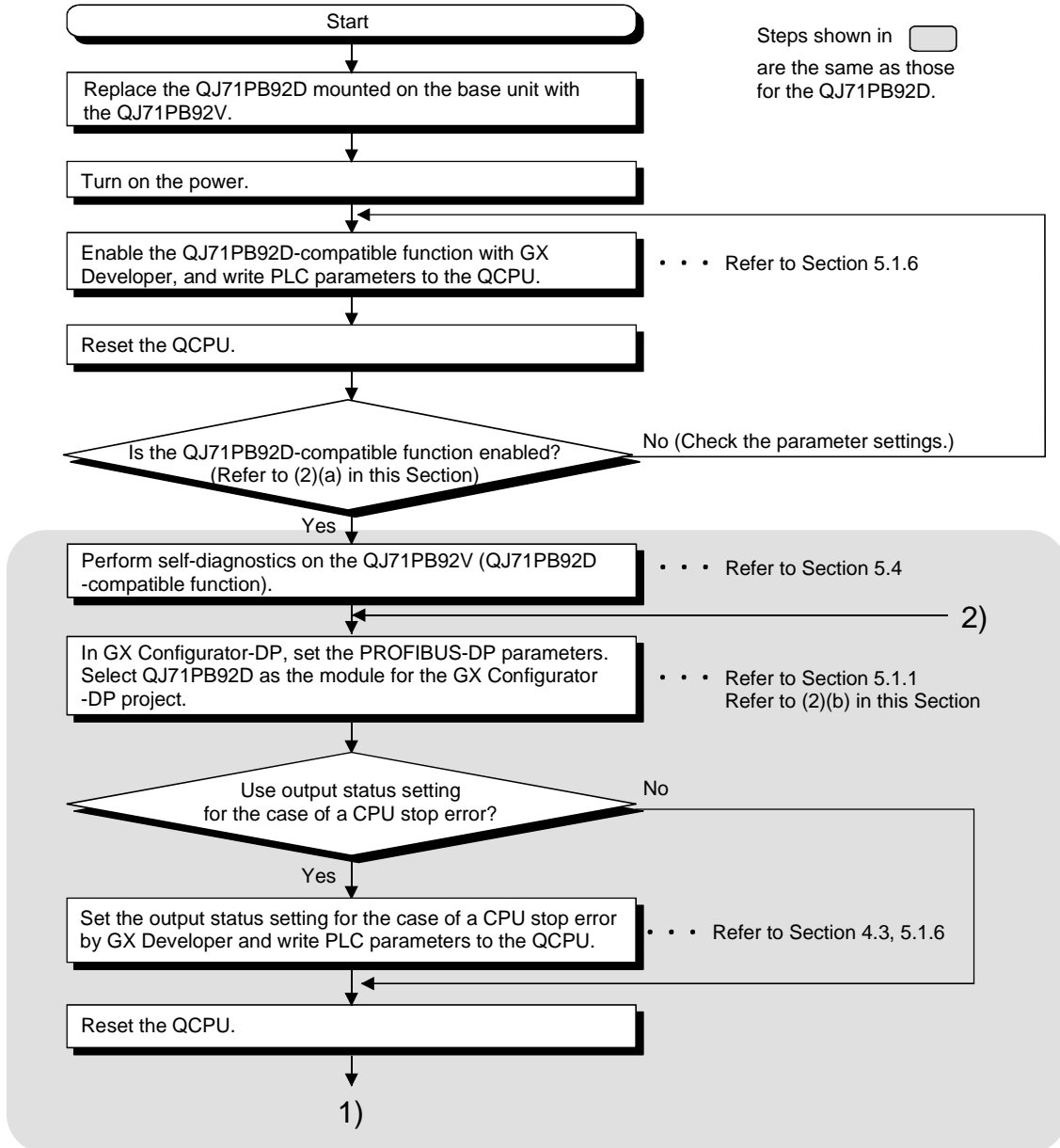

Steps shown in  are the same as those for the QJ71PB92D.

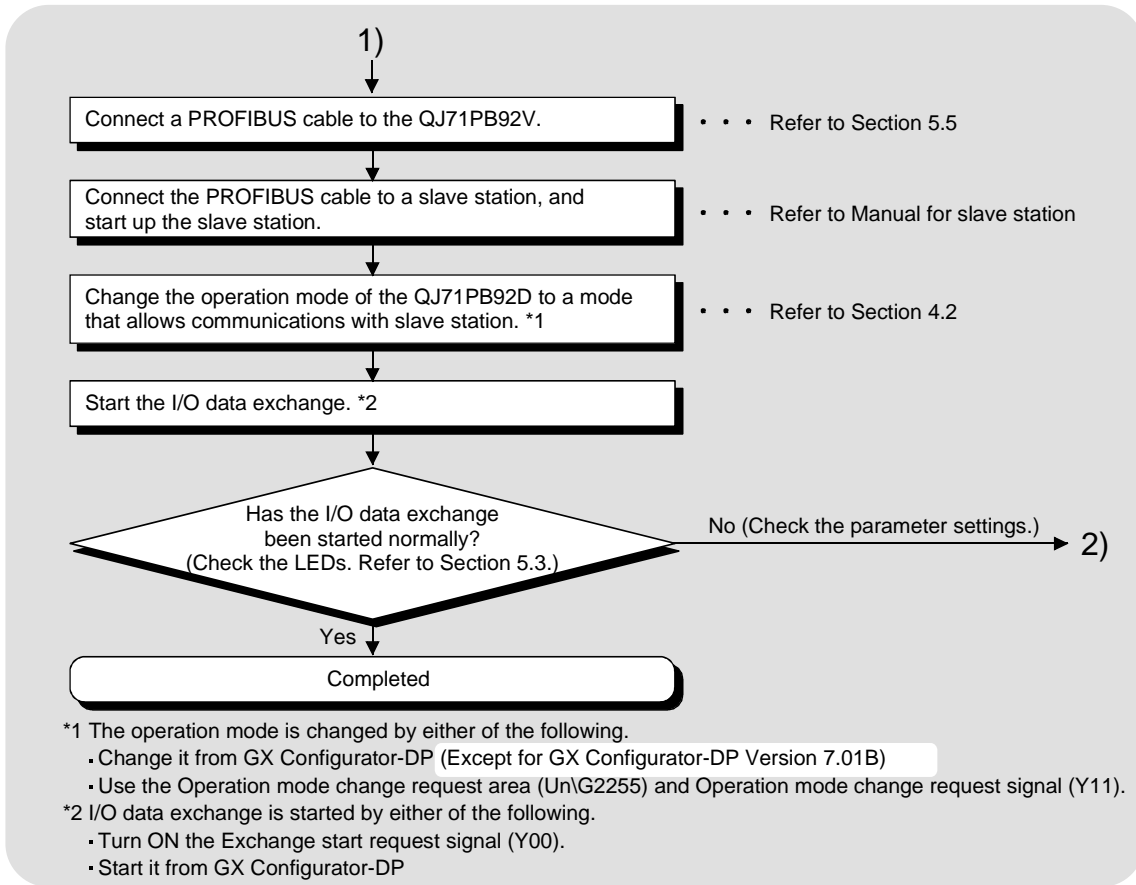



- (a) Checking if the QJ71PB92D-compatible function is enabled  
 The model name displayed in Module's Detailed Information of GX Developer is changed to "QJ71PB92D (92V)"

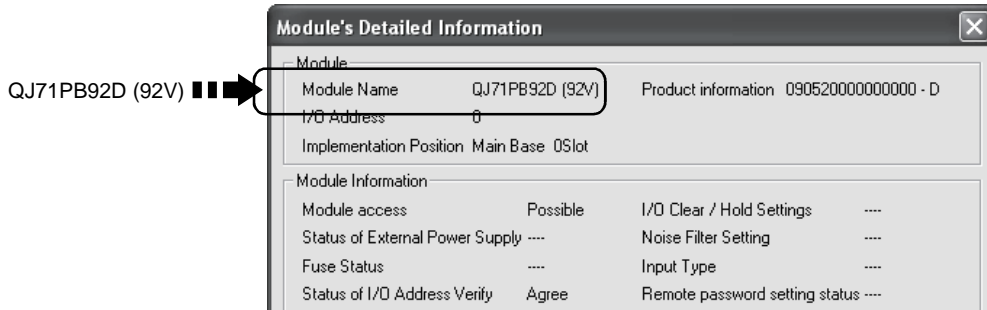

- (b) Module to be selected in GX Configurator-DP projects  
 1) When utilizing the project created for the QJ71PB92D  
 Utilize the project without change.

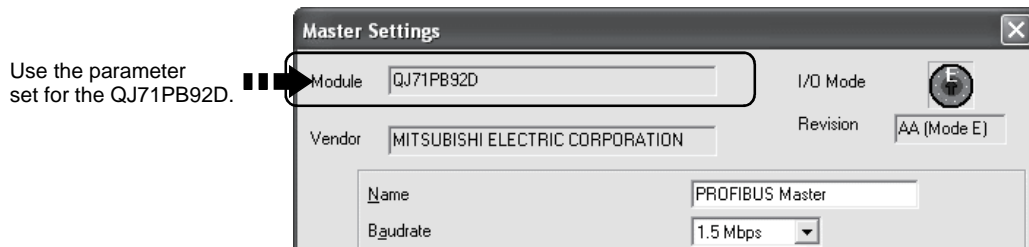

- 2) When creating a new project  
 Select QJ71PB92D for the module.

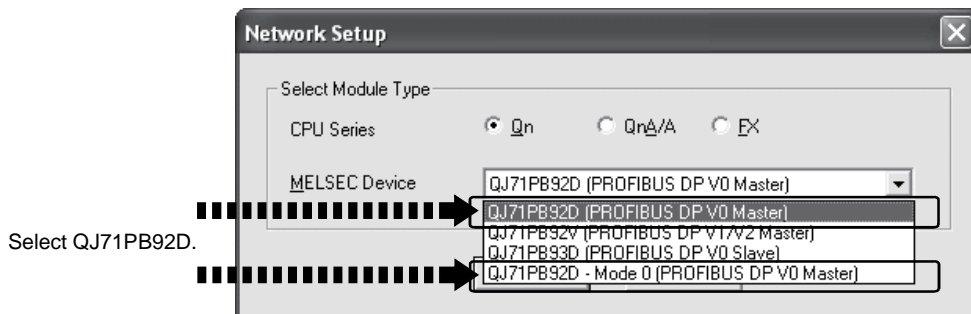

- (c) When no matching module is identified in GX Configurator-DP  
 The following dialog box is displayed in GX Configurator-DP.

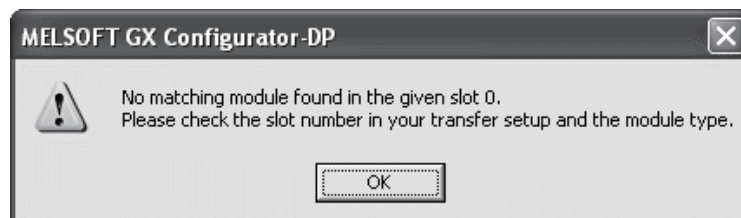

If the above dialog box appears, check if:

- The module selected in the GX Configurator-DP project is QJ71PB92D.
- The version of the GX Configurator-DP is any other than Version 7.00A.
- The "Module Slot" setting in "Transfer Setup" of GX Configurator-DP is correct.

5.1.1 Parameter setting procedure

The following describes the QJ71PB92D parameter setting procedure.

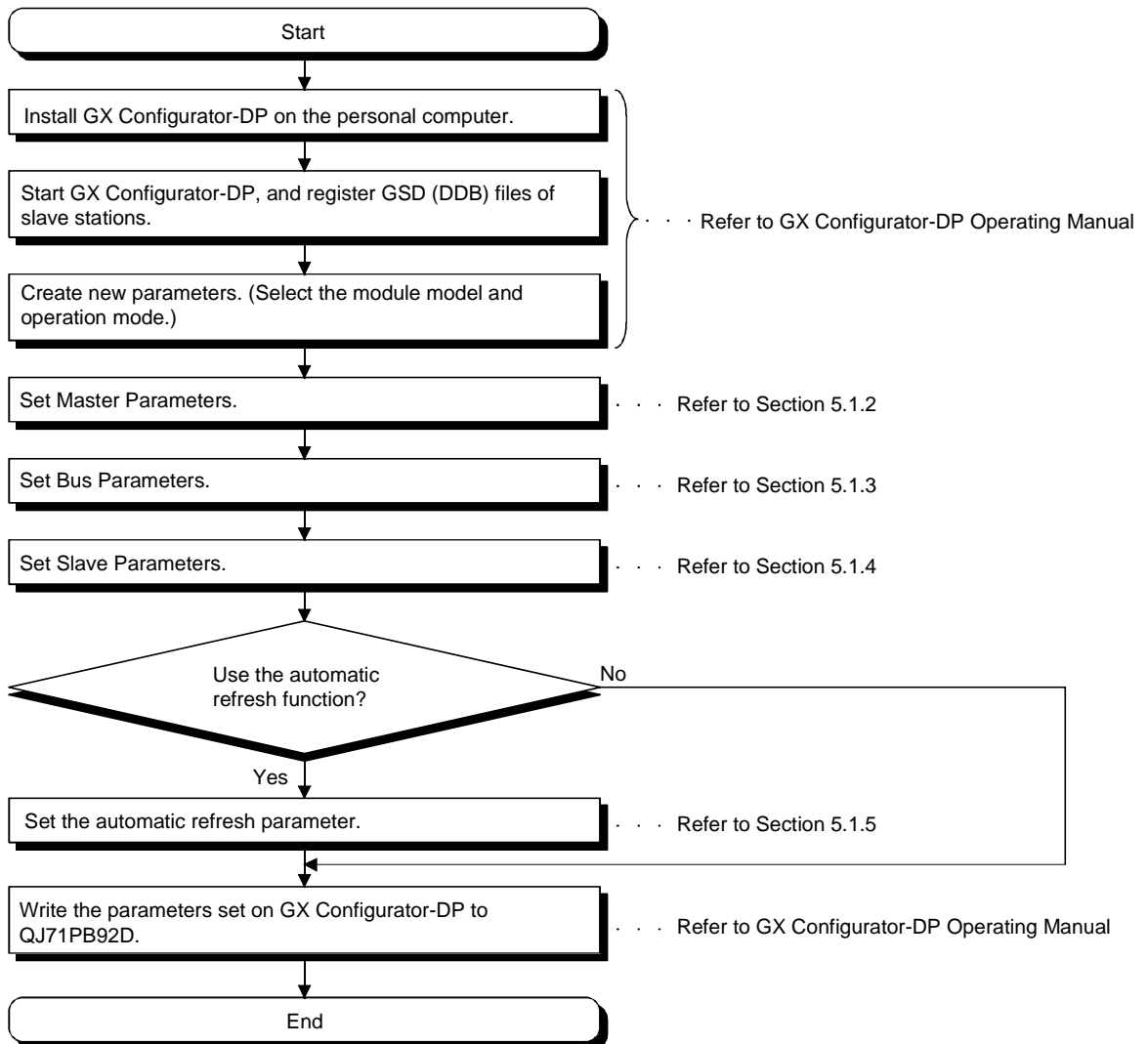

**IMPORTANT**

Do not turn off the power or reset the CPU module while the parameters are being written using GX Configurator-DP.  
 To do so may result in repair of the QJ71PB92D.  
 Follow the screen instructions of GX Configurator-DP.

5.1.2 Master parameters

Set the QJ71PB92D's transmission speed, station number and other parameters.

(1) Start procedure

(a) Right-click on the master station graphic → [Modify Settings].

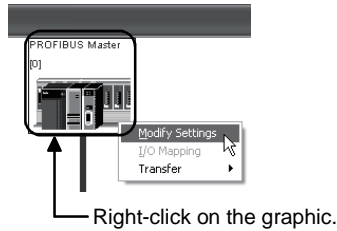

(2) Setting items

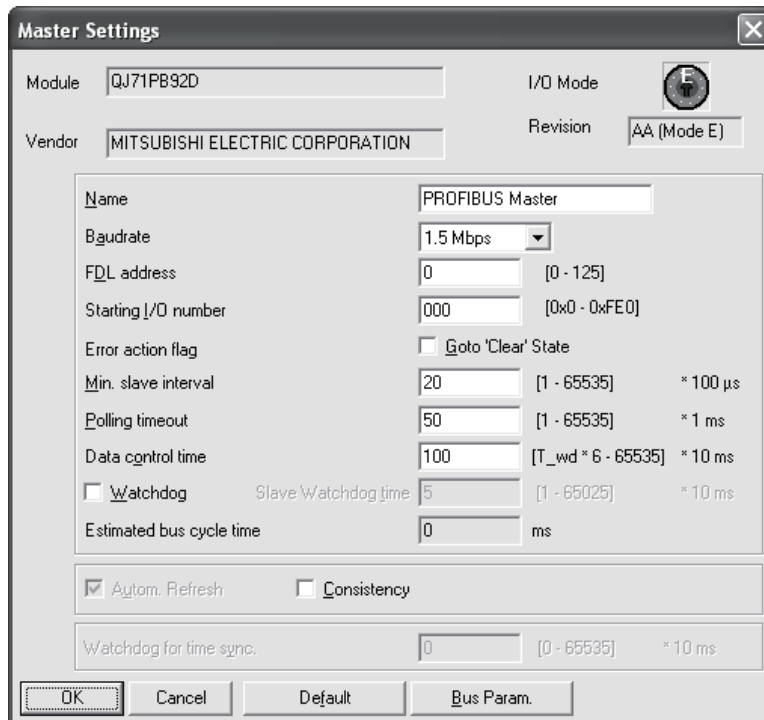

Item	Description
Name	Set the name of the master station. Setting range: Up to 17 alphanumeric characters
Baudrate	Set the transmission speed of the PROFIBUS-DP. Setting range: 9.6 kbps to 12 Mbps (Default: 1.5 Mbps)
FDL address	Set the FDL address (station number). Setting range: 0 to 125 (Default: 0)

(To the next page)

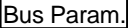
Item	Description
Starting I/O number	Set the first 3 digits of starting I/O number of the QJ71PB92D expressed in 4 digits. Set this item when using the "POU for GX IEC Developer" command of the GX Configurator-DP. Setting range: 000H to *1 (Refer to *1) (Default: 000H)
Error action flag	Check this checkbox when sending a clear request to all slave stations from the master station. When a communication error occurs even in one slave station, the clear request is sent to all slave stations. Not checked: The clear request is not sent to all slave stations. Checked: The clear request is sent to all slave stations.
Min. slave interval	Set the minimum required time from the slave polling cycle to the next one. This set value is enabled on all connected slave stations. Set a value for the slave station that needs the longest time. Setting range: 1 to 65535 (Unit: $\times 100\mu\text{s}$ , Default: $20 \times 100\mu\text{s}$ )
Polling timeout	Set the maximum time required for a requester to receive the response in communication between master stations. Setting range: 1 to 65535 (Unit: $\times 1 \text{ ms}$ , Default: $50 \times 1 \text{ ms}$ )
Data control time	Set the time during which the QJ71PB92D notifies of the slave station operation status. Set a value of 6 times or more the watchdog timer set value of the slave station. Setting range: 1 to 65535 (Unit: $\times 10 \text{ ms}$ , Default: $100 \times 10 \text{ ms}$ )
Watchdog	Check this checkbox to enable the watchdog timer on all slave stations. When the "Watchdog" checkbox is checked in the master parameter setting, "Watchdog" in the slave parameters cannot be set. Not checked: The watchdog timer setting of all slave stations is disabled. Checked: The watchdog timer setting of all slave stations is enabled.
Slave Watchdog time	Set a watchdog timer value for all slave stations. This setting is available when "Watchdog" is checked. Setting range: 1 to 65025 (Unit: $\times 10 \text{ ms}$ , Default: $5 \times 10 \text{ ms}$ )
Estimated bus cycle time	A reference value for bus cycle time, which is calculated from GX Configurator-DP parameters, is displayed. Set a value greater than the displayed value for "Min. slave interval" or "Watchdog". Note that, since the displayed value is a value calculated from GX Configurator-DP parameters, the actual bus cycle time may be longer than the displayed time due to communication with another master station. (Refer to Section 6.1.) Set sufficient time for "Min. slave interval" or "Watchdog", considering the time that will be spent for communications with another master station.
Autom. Refresh	Automatic refresh enabled/disabled is displayed. Automatic refresh enabled/disabled is set in "PLC and GX IEC Developer (GID) Settings" (Refer to Section 5.1.5(2)) Not checked: Automatic refresh disabled Checked: Automatic refresh enabled
Consistency	Check this checkbox to use the data separation prevention function when automatic refresh is executed. When "Autom. Refresh" is enabled, the checkbox is available. Not checked: Data separation prevention function disabled Checked: Data separation prevention function enabled
 button	Displays the Bus Parameter screen. (Refer to Section 5.1.3)

\*1 The upper limit of the setting range for "Starting I/O number" varies depending on the CPU module for which the master module is installed.

For details, refer to the manual of the CPU module.

**POINT**

When "Error action flag" is checked, outputs of all slave stations are cleared when a communication error occurs even in one slave station.

To restart output, perform either of the following operations.

- Turn OFF the exchange start request signal (Y00) and then turn it ON.
- Reset the QCPU.

5.1.3 Bus parameters

Set the PROFIBUS-DP parameters.

Normally, the bus parameters are used as default values.

When changing some of the bus parameters, make sure of the PROFIBUS-DP standard in advance.

(1) Start procedure

- (a) Right-click on the master station graphic → [Modify Settings].
- (b) Click the Bus Param. button in the Master Settings screen.

(2) Setting items

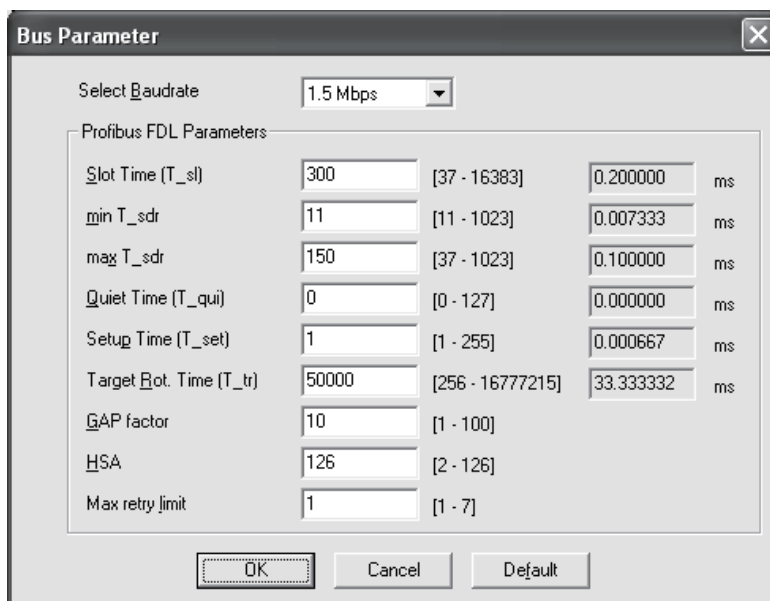

Item	Description
Select Baudrate	Sets the transmission speed of the PROFIBUS-DP. When the set value is changed on this screen, the "Baudrate" value in the master parameter settings is also changed automatically. Setting range: 9.6 kbps to 12 Mbps (Default: 1.5 Mbps)
Slot Time (T_sl)	Set the slot time (maximum time for waiting for a response). If this set time is exceeded, an error will be detected. Setting range: 37 to 16383 (Unit: ×TBit, Default: Depends on the transmission speed)
min T_sdr	Set the minimum response time of responders. Setting range: 11 to 1023 (Unit: × TBit, Default: 11 × TBit)
max T_sdr	Set the maximum response time of responders. Setting range: 37 to 1023 (Unit: × TBit, Default: Depends on the transmission speed)
Quiet Time (T_qui)	Set the repeater switching time (the time required for switching the transmission direction of the repeater). Set 0 when the network does not contain a repeater. Setting range: 0 to 127 (Unit: × TBit, Default: Depends on the transmission speed)

(To the next page)

Item	Description
Setup Time (T <sub>set</sub> )	Set the setup time. Setting range: 1 to 255 (Unit: × T <sub>Bit</sub> , Default: Depends on the transmission speed)
Target Rot. Time (T <sub>tr</sub> )	Set the target token rotation time. Setting range: 256 to 16777215 (Unit: × T <sub>Bit</sub> , Default: 50000 × T <sub>Bit</sub> )
GAP factor	Set a constant for controlling the GAP update time (T <sub>gud</sub> ). Setting range: 1 to 100 (Default: 10)
HSA	Set the highest station number of slave stations that exist on the network. Setting range: 2 to 126 (Default: 126)
Max retry limit	Set the maximum number of retries for individual data transmission. Setting range: 1 to 7 (Default: Depends on the transmission speed)

**REMARK**

[T<sub>Bit</sub>] (Bit Time) is a unit that expresses the time required for 1-bit data transmission as "1".

The actual processing time differs as shown below depending on the transmission speed.

- In the case of 1.5 Mbps,  $1[T_{\text{Bit}}] = 1 / (1.5 \times 10^6) = 0.667 \times 10^{-6}[\text{s}]$
- In the case of 12 Mbps,  $1[T_{\text{Bit}}] = 1 / (12 \times 10^6) = 0.083 \times 10^{-6}[\text{s}]$

T<sub>Bit</sub> is converted into ms automatically on GX Configurator-DP.

The results of the conversion (ms) are displayed on the right side of the screen.

**(3) Precautions for bus parameter setting**

For each set value of the max T<sub>sdr</sub>, Quiet Time (T<sub>qui</sub>) and Setup Time (T<sub>set</sub>), set the maximum value among those of the stations connected to PROFIBUS-DP (including the master station).

The default value of the QJ71PB92D varies depending on the transmission speed.

Item	Default Values of QJ71PB92D					
	187.5kbps or less	500kbps	1.5Mbps	3Mbps	6Mbps	12Mbps
max T <sub>sdr</sub>	60	100	150	250	450	800
Quiet Time (T <sub>qui</sub> )	0	0	0	3	6	9
Setup Time (T <sub>set</sub> )	1	1	1	4	8	16

5.1.4 Slave parameters

Set parameters for each slave station.

(1) Start procedure

(a) Right-click on the graphic of cable → [Insert DP-Slave].

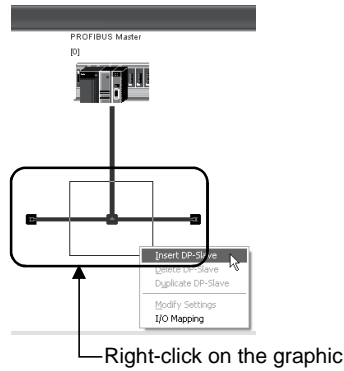

(b) Select a slave station in the Device Database screen.

(2) Setting items

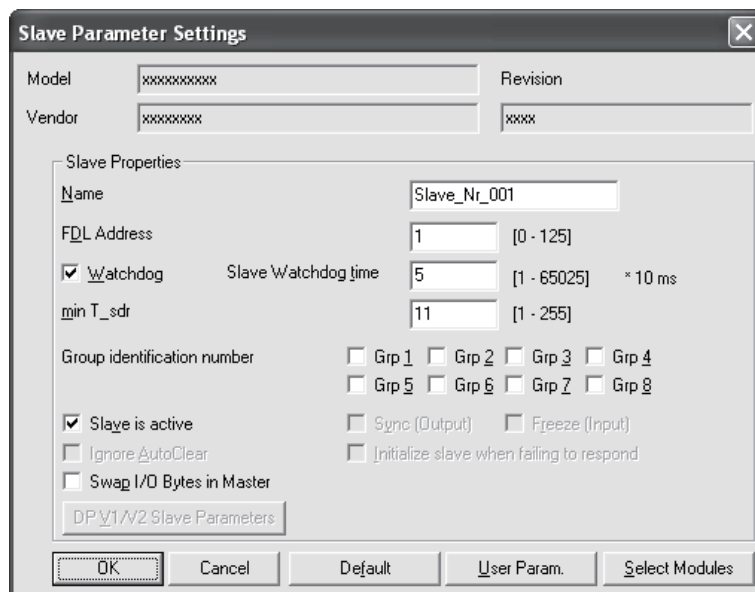



Item	Description
Name	Set the name of the slave station. Setting range: max. 17 alphanumeric characters
FDL Address	Set the FDL address (station number). Setting range: 0 to 125
Watchdog	<p>Check this checkbox to use a watchdog timer. When this setting is enabled, a communication error is detected if no data are received from the QJ71PB92D within the time specified in "Slave Watchdog time". (When disabled, a communication error is not detected even if data are no longer received from the QJ71PB92D.) Once the "Watchdog" checkbox has been checked in the master parameter setting, "Watchdog" in the slave parameters cannot be set. Not checked: Watchdog timer disabled (Default) Checked: Watchdog timer enabled</p> <p>Whether or not output data at the time of error communication are output from each slave station to external devices differs depending on the slave station setting. For details, refer to the manual for the slave station.</p>
Slave Watchdog time	Set the time of the watchdog timer. This setting is available when "Watchdog" is checked. The set value must satisfy the following condition: Bus cycle time $\leq$ Set value of "Slave Watchdog time" $\leq$ (Set value of "Data control time") / 6 Setting range: 1 to 65025 (Unit: $\times 10$ ms or $\times 1$ ms, Default: $5 \times 10$ ms)
min T_sdr	Set the minimum response time required for a slave station to send a response frame to the QJ71PB92D. Normally, use the default value. Setting range: 1 to 255 (Unit: $\times T_{Bit}$ , Default: $11 \times T_{Bit}$ )
Group identification number	Set the group No. (Grp 1 to Grp 8) of the slave station. Multiple groups Nos. can also be set. Not checked: Not belonging to the group No. Checked: Belonging to the group No.
Slave is active	Uncheck the box when the slave station is to be set as a reserved station. Not checked: Set as a reserved station. Checked: Set as a station performing I/O data exchange.
Sync (Output)	Check the box to check if the slave station supports the Sync function or not in communication for initialization. When the slave station does not support the Sync function, trouble information is stored in the communication trouble area (Un\G2040 to Un\G2079) of the QJ71PB92D. Not checked: No function check Checked: Function check performed
Freeze (Input)	Check the box to check if the slave station supports the Freeze function or not in communication for initialization. When the slave station does not support the Freeze function, the trouble information is stored in the communication trouble area (Un\G2040 to Un\G2079) of the QJ71PB92D. Not checked: No function check Checked: Function check performed

(To the next page)

Item	Description
Swap I/O Bytes in Master	Check this box to swap the I/O data of the slave station on the QJ71PB92D buffer memory. Not checked: No swapping Checked: Enables data swapping
<input type="checkbox"/> User Param. button	Used when setting parameters specific to the slave station. For details, refer to the manual for the slave station.
<input type="checkbox"/> Select Modules button	Used when setting equipment mounted on the slave station. For details, refer to the manual for the slave station.

5.1.5 Automatic refresh parameters

Set the automatic refresh parameters by which data in the QJ71PB92D buffer memory are automatically transferred to QCPU devices.

(1) Automatic refresh parameter setup procedure

The following describes the automatic refresh parameter setup procedure.

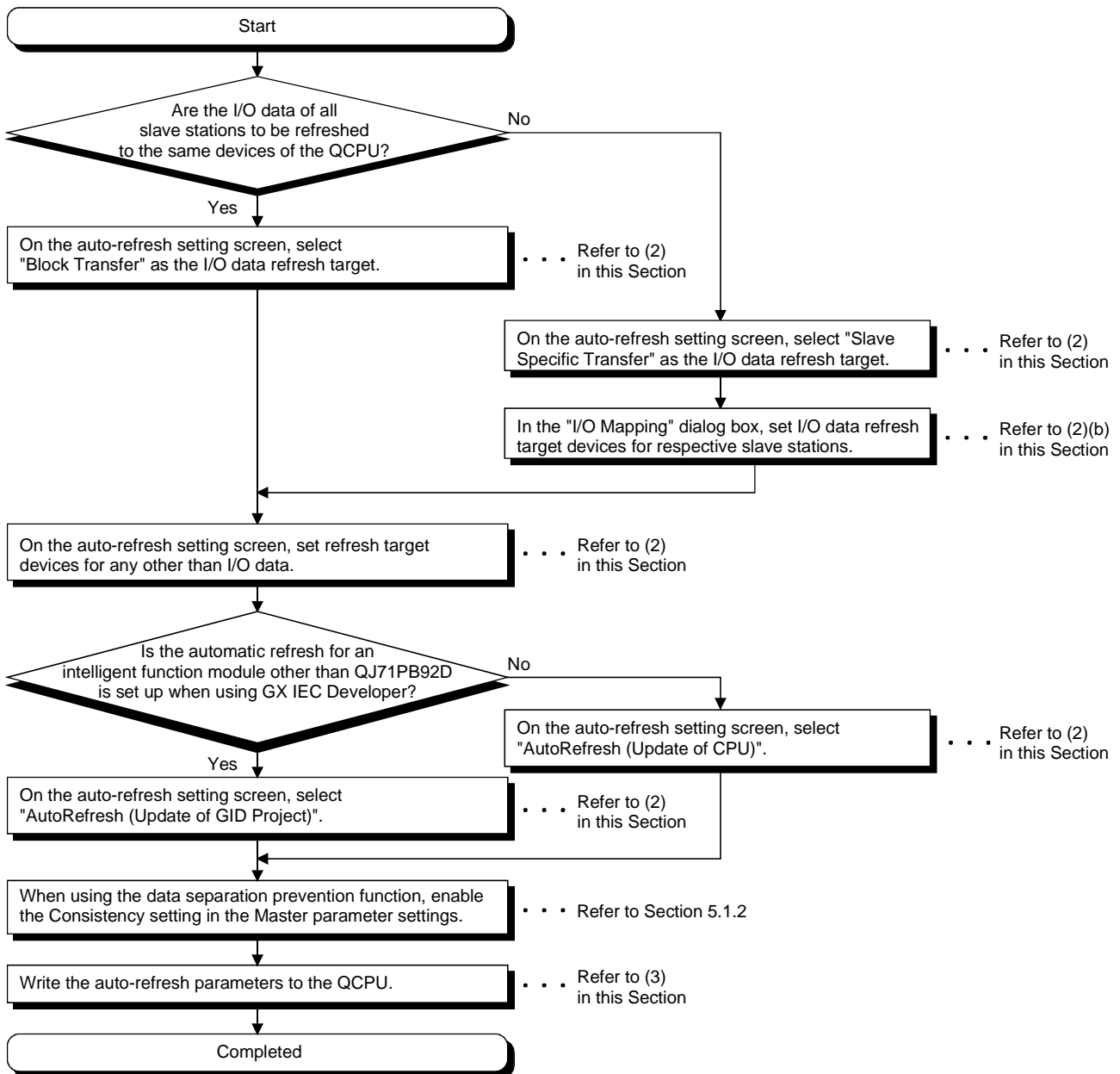

(2) Automatic Refresh Settings

(a) PLC and GX IEC Developer (GID) Settings screen

Set the automatic refresh setting.

1) Operation procedure

[Setup] → [PLC and GX IEC Developer (GID) Settings]

2) Setting items

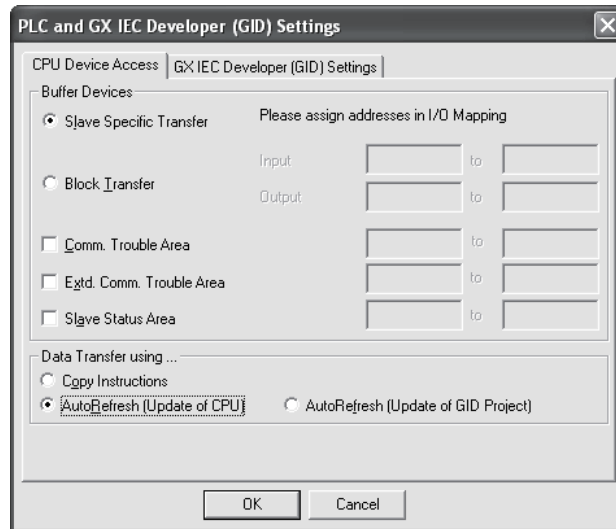

Item	Description
Buffer Devices	Set the CPU module devices used in the communication between the QJ71PB92D and the CPU module.
Slave Specific Transfer	Select this item when setting devices used in the communication in units of slave stations. Devices can be set by the "Buffer MIT-Address" of each slave station in the "I/O Mapping" dialog box after selecting this item. (Refer to (2)(b) in this Section)
Block Transfer	Select this item when setting devices used in the communication to the same kinds of devices of all slave stations. Devices are set in the following "Input" or "Output". Input: Device used for the communication of input data is set. (Default : D1000) For a bit device, setting must be made in units of 16 points. Output: Device used for the communication of output data is set. (Default : D2000) For a bit device, setting must be made in units of 16 points.
Comm. Trouble Area	Set the automatic refresh target device of the Communication trouble area (Un\G2040 to Un\G2079).
Extd. Comm. Trouble Area	Set the automatic refresh target device of the Expansion communication trouble area (Un\G2096 to Un\G2110).
Slave Status Area	Set the automatic refresh target device of the Slave status area (Un\G2112 to Un\G2116).

(To the next page)

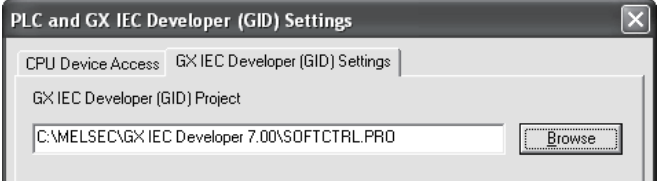
Item	Description
Data Transfer using	Set communication method between the master module and the CPU module.
Copy Instructions	Select this item in case of communication using the FROM/TO/MOV instruction and dedicated instruction.
AutoRefresh (Update of CPU)	Select this item in case of communication using the automatic refresh. If selecting this item, automatic refresh parameters are written to the CPU module when the project is downloaded.
AutoRefresh (Update of GID Project)	<p>Select this item in case of communication using the automatic refresh. If selecting this item, automatic refresh parameters are written to the project file of GX IEC Developer. The project file of GX IEC Developer is set with "GX IEC Developer (GID) Settings" tab.</p>  <p>Writing to the CPU module can be performed from GX IEC Developer.</p>

<b>POINT</b>
Set "Block Transfer" for the following applications. <ul style="list-style-type: none"> <li>• To refresh I/O data of all slave stations into the same kind of device</li> <li>• To reduce the number of automatic refresh parameters of the QJ71PB92D, and increase the automatic refresh parameters of other intelligent function modules</li> </ul>

(b) I/O Mapping dialog box

Set the devices used for the communication in units of slave stations.

1) Operation procedure

Right-click on the graphic of master station → [I/O Mapping]

2) Setting items

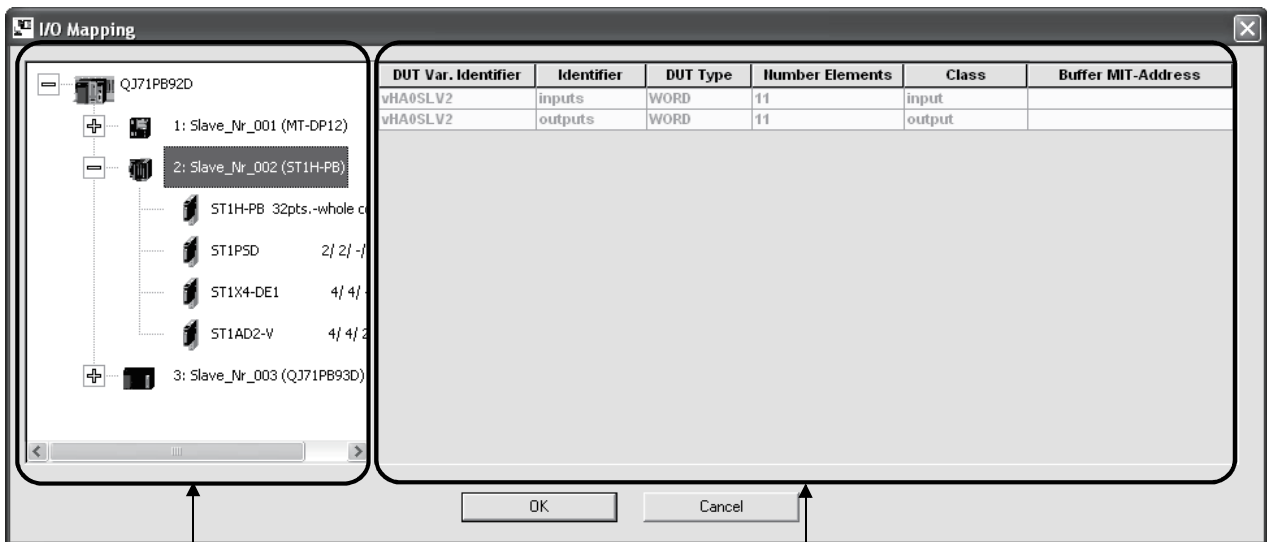

Tree view

Table view

• Tree view

On the highest level, the model name of the master station is displayed.

On the second level, the following information on the slave stations is displayed.

- FDL addresses
- Slave station names set in the "Slave Parameter Settings" dialog box.
- Model names

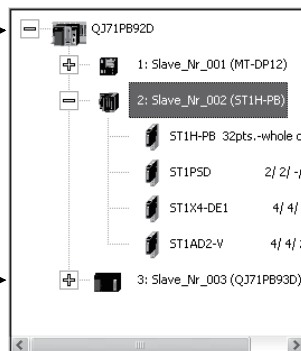

On the third level, the model names of the modules mounted on the slave stations.

- Table view

When selecting a module of slave stations in the tree view, the following DUT element is displayed in the table view.

Item	Description
DUT Var. Identifier	Automatically creates and displays the name of the global variable instance of the DUT.
Identifier	Displays name of the DUT element.
DUT Type	Displays the data type of the DUT element or global variable.
Number Elements	Displays the number of elements. When this item is 2 or larger, the element is an array.
Class	Displays whether data to be treated is input or output data. input: Input data output: Output data
Global Var. Identifier	Sets any global variable name. If set, any global variable name can be used at the time of programming. This item can be set when selecting the module of slave station from tree view.
User MIT-Address	Sets devices to be relayed when accessing to I/O data in a program of GX IEC Developer. Devices to be set cannot be duplicated with other modules. Set devices so as not to be duplicated. For details of "User MIT-Address", refer to (2)(b) 3) in this section. This item can be set when selecting the module of slave station from the tree view.
Buffer MIT-Address	Displays or sets the CPU module devices used in the communication between the QJ71PB92D and the CPU module. This item can be set when selecting "Slave Specific Transfer" from the "PLC and GX IEC Developer (GID) Settings" dialog box and selecting slave station from the tree view.

### 3) User MIT-Address

When accessing to the device set at "User MIT-Address" in a program of GX IEC Developer, accessing to the I/O data is enabled.

When the address of I/O data is changed due to increase and decrease of modules, the address is recalculated by the I/O Mapping. Therefore, when exporting and incorporating the user library again, accessing to the I/O data is enabled as well as before increase or decrease of modules.

A program needs no modification.

### (3) Writing Automatic Refresh Parameters

Write the automatic refresh parameters to the QCPU.

Reset the QCPU after writing the automatic refresh parameters.

Before writing them, check the "PLC and GX IEC Developer (GID) Settings" screen to see that "AutoRefresh (Update of CPU)" or "AutoRefresh (Update of GID Project)" is selected.

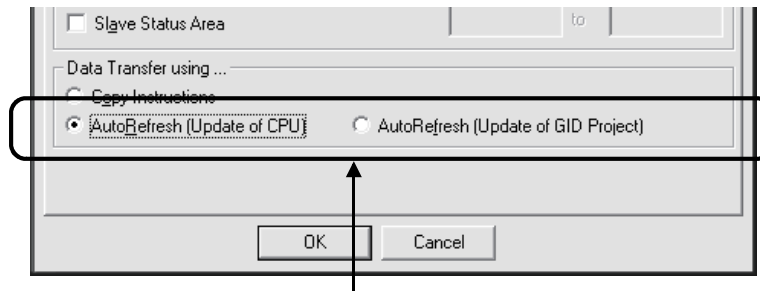

Verify that either of them is selected.

#### (a) Start procedure

- 1) [Online] → [Transfer] → [Download to Module]
- 2) If "AutoRefresh (Update of GID Project)" is selected, write the automatic refresh parameters by GX IEC Developer after the above 1).

#### POINT

When automatic refresh parameters were written from GX Configurator-DP while GX Developer was running, they are not displayed in file lists such as Read from PLC, Delete PLC data on GX Developer.

Update the file lists by the **Refresh view** button of the Read from PLC or Delete PLC data on GX Developer.



(4) Number of set automatic refresh parameters

There are restrictions on the number of automatic refresh parameters that can be set for CPU modules.

Set automatic refresh parameters properly so that the number of the parameters does not exceed the limit shown below.

(a) Number of automatic refresh parameters set for all intelligent function modules

When multiple intelligent function modules are mounted, the number of automatic refresh parameter settings must not exceed the following limit.

CPU Type	Max. No. of Auto-refresh Parameter Settings
Q00J/Q00/Q01CPU	256
Q02/Q02H/Q06H/Q12H/Q25HCPU	256
Q12PH/Q25PHCPU	256
Q03UD/Q04UDH/Q06UDHCPU	2048

(b) Number of automatic refresh parameter settings for the QJ71PB92D

The number of automatic refresh parameter settings for the QJ71PB92D varies depending on the automatic refreshing setting method for I/O data.

1) When "Block Transfer" is used

When the automatic refresh of I/O data is set by "Block Transfer" (i.e. I/O data of all slave stations are refreshed into the same kind of device), up to five automatic refresh parameters can be set per QJ71PB92D.

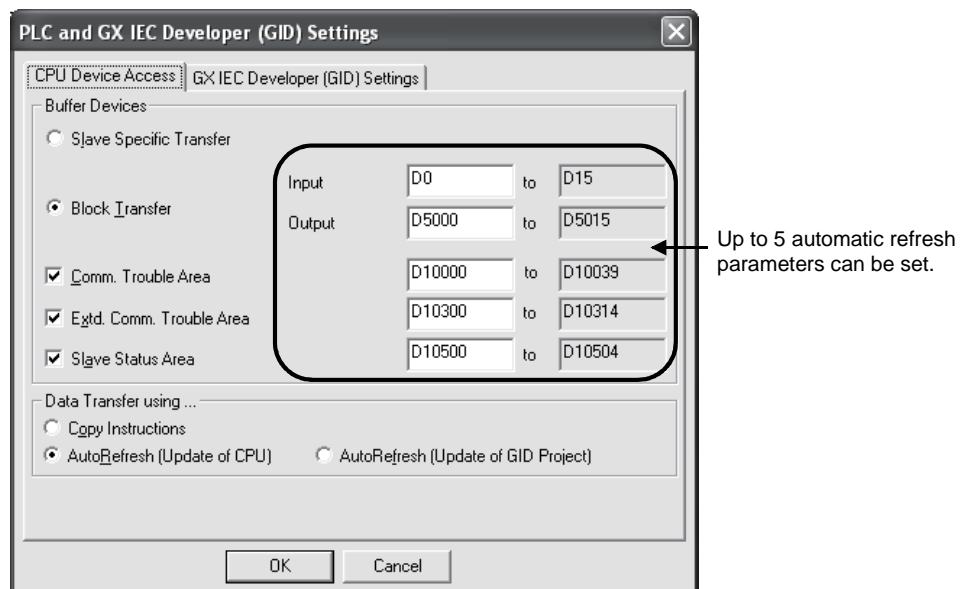

2) When "Slave Specific Transfer" is used

When the automatic refresh of I/O data is set by "Slave Specific Transfer" (i.e. when changing the refresh target device on a per-DP-Slave basis), the following number of automatic refresh parameters can be set per QJ71PB92D.

Max. number of settings  
 = {(Number of connected slave stations) × 2} + 3

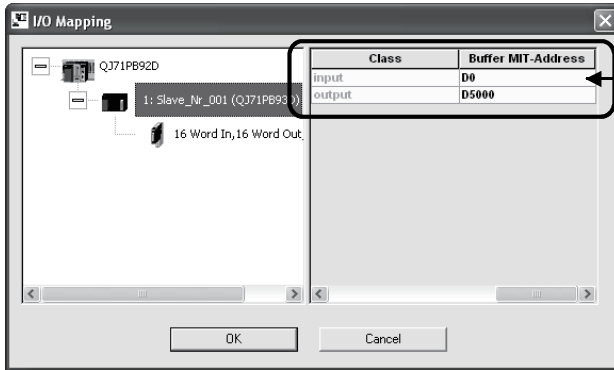

Set automatic refresh parameters for the "No. of slave stations connected to the QJ71PB92D x 2".

Set automatic refresh parameters for the total.

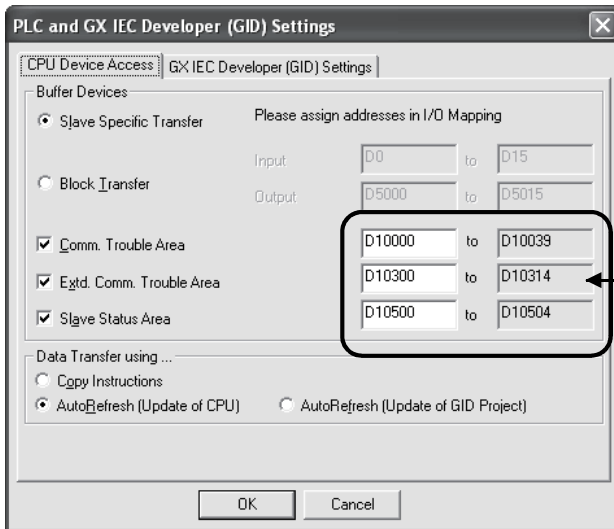

Up to 3 automatic refresh parameters can be set.

5.1.6 Intelligent function module switch setting

Set the output status setting for the case of a CPU stop error and the QJ71PB92D-compatible function.

(1) Start procedure

- 1) Double-click “PLC parameter” in the project window of GX Developer.
- 2) Enter I/O data on the I/O assignment screen, and click the **Switch setting** button.

(2) Setting items

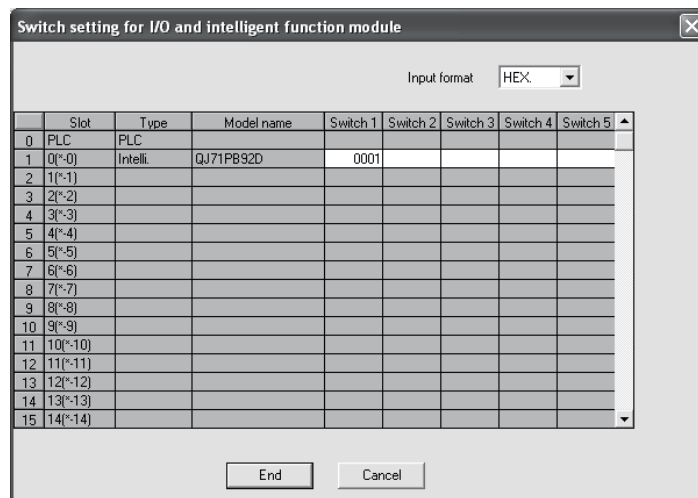

(a) For the QJ71PB92D

QJ71PB92D

Item	Description
Switch 1	Set whether to continue or stop the I/O data communication with the slave station when the CPU stop error occurs. Continue : No setting (blank) Stop : 0001H
Switch 2	No setting (blank). If any setting exists, delete it.
Switch 3	
Switch 4	
Switch 5	

(b) For the QJ71PB92V (QJ71PB92D-compatible function)

QJ71PB92V  
(92D-compatible)

Item	Description
Switch 1	Set whether to continue or stop the I/O data communication with the slave station when the CPU stop error occurs. Continue : No setting (blank) Stop : 0001H
Switch 2	9244H
Switch 3	No setting (blank). If any setting exists, delete it.
Switch 4	
Switch 5	

## 5.2 Installation

This section provides the handling precautions, from unpacking to installation of the QJ71PB92D.

For details on implementation and installation of the QJ71PB92D, refer to the "QCPU User's Manual (Hardware Design, Maintenance and Inspection)."

### 5.2.1 Handling precautions

- (1) Do not drop the module case or subject it to heavy impact since it is made of resin.
- (2) Do not remove the PCB of each module from its case. This may cause a failure in the module.
- (3) Be careful not to let foreign objects such as wire chips enter the module during wiring. In the event any foreign object enters, remove it immediately.
- (4) The top surface of the module is covered with a protective film to prevent foreign objects such as wire chips from entering the module during wiring. Do not remove this film until the wiring is complete. Before operating the system, be sure to remove the film to provide adequate heat ventilation.
- (5) Tighten the module fixing screws and connector mounting screws using torque within the following ranges.

Screw location	Tightening torque range
Module fixing screw (M3 screws) * <sup>1</sup>	0.36 to 0.48 N · m
PROFIBUS cable connector mounting screws (#4 - 40UNC screws)	0.20 to 0.28 N · m

\*1 The module can be easily fixed onto the base unit using the hook at the top of the module.

However, it is recommended to secure the module with the module mounting screw if the module is subject to significant vibration or shock.

### 5.2.2 Installation environment

Refer to QCPU User's Manual (Hardware Design, Maintenance and Inspection).

5.3 Part Names and Settings

This section explains the names and settings of each part of the QJ71PB92D.

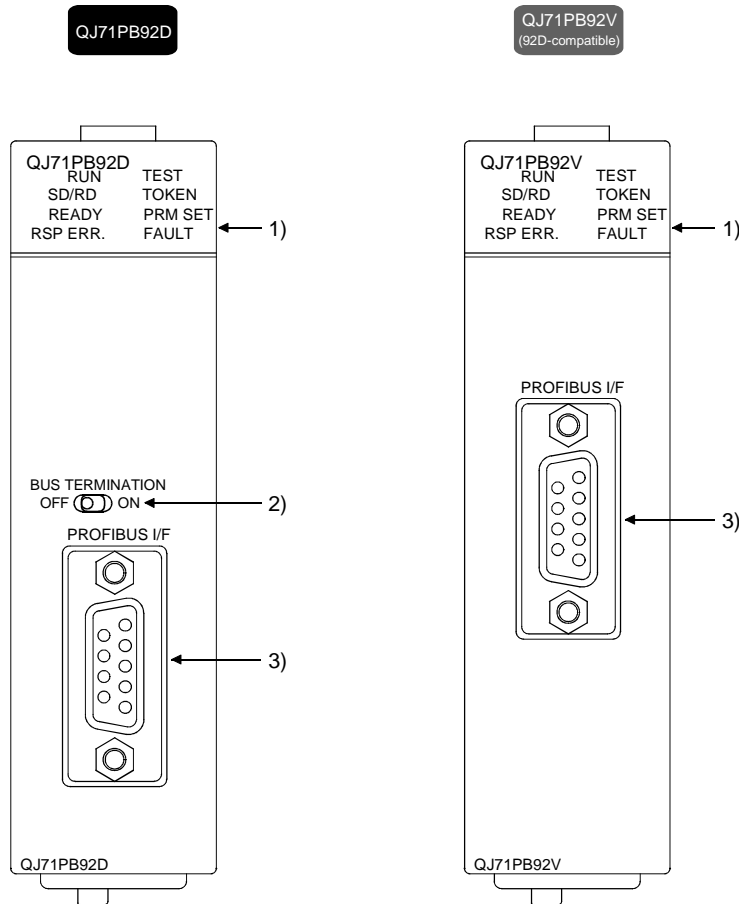

No.	Name	Description
1)	LED	These LEDs indicate the operation status. For details, refer to (1) in this section.
2)	PROFIBUS network terminal resistance setting switch* <sup>1</sup>	The switch for setting the bus terminator built in the QJ71PB92D. (Default: OFF) ON : Bus terminator OFF: No bus terminator For details, refer to Section 5.5.2.
3)	PROFIBUS interface connector* <sup>2</sup>	This connector connects the PROFIBUS cable.

\*1 Operate the PROFIBUS network terminating resistor setting switch with your fingertips. Do not use a screwdriver or similar tool. To do so may damage the switch.

\*2 For the connector type, use a male D-Sub 9 pin. The user creates the PROFIBUS cable. (for information regarding the cable wiring, refer to Section 5.5.)  
The size of the screw which can be used for the connector is #4-40 UNC.

(1) LED



LED	Status	Description	Reference
RUN	ON	Normally operating	—
	OFF	Hardware error (watchdog timer error) or power failure	Section 9.1
SD/RD	ON	Exchanging I/O data* <sup>1</sup>	Section 9.1
	Flashing		
	OFF	Not communicating with slave station	—
READY	ON	Ready to communicate or communication being performed	—
	OFF	Not ready to communicate or no communication	—
RSP ERR.	ON	A communication error has occurred	Section 3.3.2 (2), 3.4.2 (4)
	OFF	No communication error	
TEST	ON	Executing self-diagnosis or flash ROM initialization	Section 5.4, 9.5
	Flashing	Executing self-diagnosis	Section 5.4
	OFF	Not executing self-diagnosis or flash ROM initialization	—
TOKEN	ON	Token being passed* <sup>2</sup>	(2) in this section
	Flashing		
	OFF	No token passing* <sup>2</sup>	Section 9.1
PRM SET	ON	Operating in Parameter setting mode (MODE 1)	Section 4.2
	Flashing	The written parameters are invalid	Section 9.1
	OFF	Operating in operation mode other than Parameter setting mode (MODE 1)	Section 4.2
FAULT	ON	An error has occurred	Section 9.1
	OFF	Normally operating	—

\*1 The LED flashes at intervals based on the value set in "Data control time" in Master Parameters.

\*2 The LED status during token passing varies depending on the number of DP-Masters within the same network and the transmission speed setting. For details, refer to (2) in this section.

(2) TOKEN LED status

No. of master station within the Same Network	Transmission Speed	
	19.2kbps or less	93.75kbps or more
1	ON	
More than 1	Flashing	ON or OFF

## 5.4 Execution Method for Self-diagnosis

The self-diagnosis of the QJ71PB92D performs a unit test on the QJ71PB92D. It takes about 15 seconds to complete the self-diagnostics.

### (1) Self-diagnosis procedure

The following shows how to execute the self-diagnosis.

- (a) Set the operation mode of the QJ71PB92D to Self-diagnosis mode (MODE 2).

Set 02<sub>H</sub> in the Operation mode change request area (Un\G2255) and turn OFF → ON → OFF the Operation mode change request signal (Y11).

- (b) When the operation mode is set to Self-diagnosis mode (MODE 2), the self-diagnosis is automatically started.

During execution of self-diagnosis, the TEST LED is ON or flashing. Upon completion of the self-diagnosis, the LEDs on the QJ71PB92D change as shown below, storing the test result to the Self-diagnosis status code area (Un\G2258).

- When normally completed: The TEST LED turns OFF.
- When failed: The TEST and FAULT LEDs are ON.

### (2) Execution result of self-diagnosis

- (a) TEST LED OFF (When normally completed)

When the TEST LED turns OFF after execution of self-diagnosis, this indicates a normal completion.

Reset the QCPU.

- (b) TEST and FAULT LEDs ON (When failed)

If the TEST and FAULT LEDs are ON after execution of self-diagnosis, this indicates that the diagnosis failed.

Check the value stored in the Self-diagnosis status code area (Un\G2258), and retry the self-diagnosis.

If the diagnosis fails again, a QJ71PB92D hardware error is probable.

Please check the value currently stored in the Self-diagnosis status code area (Un\G2258), and consult your local Mitsubishi representative, explaining a detailed description of the problem.

- (c) Values that may be stored in the Self-diagnosis status code area (Un\G2258)

Any of the following values is stored in the Self-diagnosis status code area (Un\G2258) after execution of self-diagnosis.



Self-diagnosis status code	QJ71PB92D	QJ71PB92V (92D-compatible)
	QJ71PB92D	
QJ71PB92V (QJ71PB92D-compatible function)		
0000H	Normally completed	
8001H	Timer test error	
8002H	Interruption test error	Interruption test error Operation test error
8003H	Operation test error	—
8004H	SRAM1 test error	SRAM1 test error SRAM2 test error
8005H	SRAM2 test error	—
8006H	2-port RAM test error	
800AH	Flash memory test error (Unsuccessful deletion)	
800BH	Flash memory test error (Sum check error)	
8010H	Swap circuit test error	

5.5 Wiring

5.5.1 PROFIBUS cable wiring

The following describes the pin assignments of the PROFIBUS interface connector on the QJ71PB92D, the PROFIBUS cable wiring specifications, bus terminator and other information.

(1) Pin assignments of the PROFIBUS interface connector

The following shows the pin assignments of the PROFIBUS interface connector (D-sub 9-pin female connector) on the QJ71PB92D.

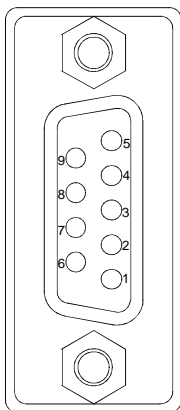

Pin No.	Signal Code	Name	Description	Cable color
1	—	SHIELD* <sup>1</sup>	Shield, Protective Ground	—
2	—	—	Open	—
3	B/B'	RxD/TxD-P	Receive/send data-P	Red
4	—	—	Open	—
5	C/C'	DGND* <sup>2</sup> * <sup>3</sup>	Data Ground	—
6	—	VP* <sup>2</sup> * <sup>3</sup>	Voltage +	—
7	—	—	Open	—
8	A/A'	RxD/TxD-N	Receive/send data-N	Green
9	—	—	Open	—

\*1 Optional signal.

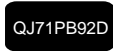

\*2 In the case of the QJ71PB92D, it is used when the built-in bus terminator is set to ON. Wiring is not needed.



\*3 In the case of the QJ71PB92V (QJ71PB92D-compatible function), this signal is used for connecting a bus terminator.

(2) PROFIBUS cable

The following shows the PROFIBUS cable and wiring specifications.

(a) PROFIBUS cable

Use a PROFIBUS cable that meets the following specifications (EN 50170 Volume 2 Type A compliant).

Item	Transmission line
Applicable cable	Shielded twisted pair cable
Impedance	135 to 165 Ω (f=3 to 20 MHz)
Capacity	Less than 30 pF/m
Conductor resistance	Less than 110 Ω/km
Cross-sectional area	0.34mm <sup>2</sup> or more (22AWG)

(b) Wiring specifications

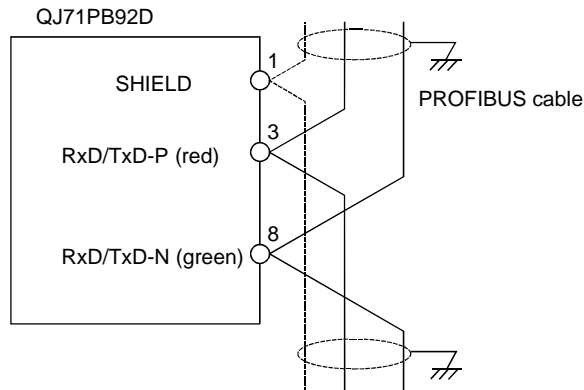

(3) Connector

Use a D-sub 9-pin male connector for the PROFIBUS cable.  
The applicable screw size is #4-40 UNC.

QJ71PB92V  
(92D-compatible)

**POINT**

The PROFIBUS interface connector position on the QJ71PB92V is moved up by 17mm (0.67 inch), compared with the QJ71PB92D.  
If the PROFIBUS cable is not long enough, extend the cable length by using an extension connector.

**QJ71PB92D**

QJ71PB92D

**QJ71PB92V  
(92D-compatible)**

QJ71PB92V

17mm  
(0.67 inch)

(4) PROFIBUS equipment

The PROFIBUS cables, connectors and other PROFIBUS equipment must be purchased or obtained at user's discretion.

For details on PROFIBUS equipment, access the following website.

- PROFIBUS International: <http://www.profibus.com/>

5.5.2 Terminator

QJ71PB92D

(1) For the QJ71PB92D

(a) Terminator switch

Whether or not to set the built-in module terminal resistance (1/2W 220 Ω x 2 units) can be selected by connecting a switch. (The stations on both ends of the PROFIBUS segment must be connected with terminal resistor.)

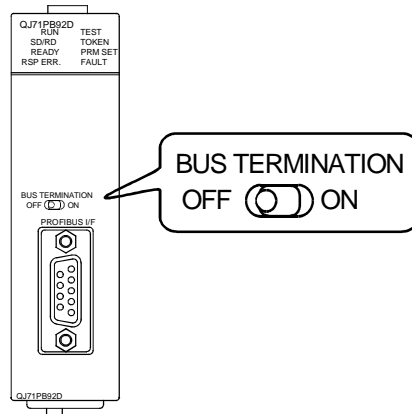

Silk display	OFF	ON
BUS TERMINATION	Disconnects terminal resistor (setting at time of shipment)	Connects terminal resistor

(b) When the QJ71PB92D's bus termination switch is set to on (has terminal resistor).

Do not remove the PROFIBUS cable from the QJ71PB92D during PROFIBUS-DP network operation. If the cable is removed, then the terminal resistor in the network will disappear, causing an error and bringing down the network.

QJ71PB92V (92D-compatible)

(2) For the QJ71PB92V (QJ71PB92D-compatible function)

The QJ71PB92V does not have a built-in bus terminator. Use a connector with a built-in bus terminator for the QJ71PB92V.

### 5.5.3 Precautions against wiring

As one of the requirements to give full play to QJ71PB92D's functions and make up the system with high reliability, it is necessary to have an external wiring unsusceptible to an influence of noise. Precautions against external wiring of QJ71PB92D is described below.

#### (1) Communication cable wiring

Do not route the wire of QJ71PB92D close to or bundle it together with the main circuit and high-tension lines, or the load-carrying lines from other than the programmable controller.

Doing so may cause the QJ71PB92D to be affected by noise and surge induction.

#### (2) Wiring from I/O modules among programmable controllers

Keep the PROFIBUS cable away from I/O module cables as much as possible.

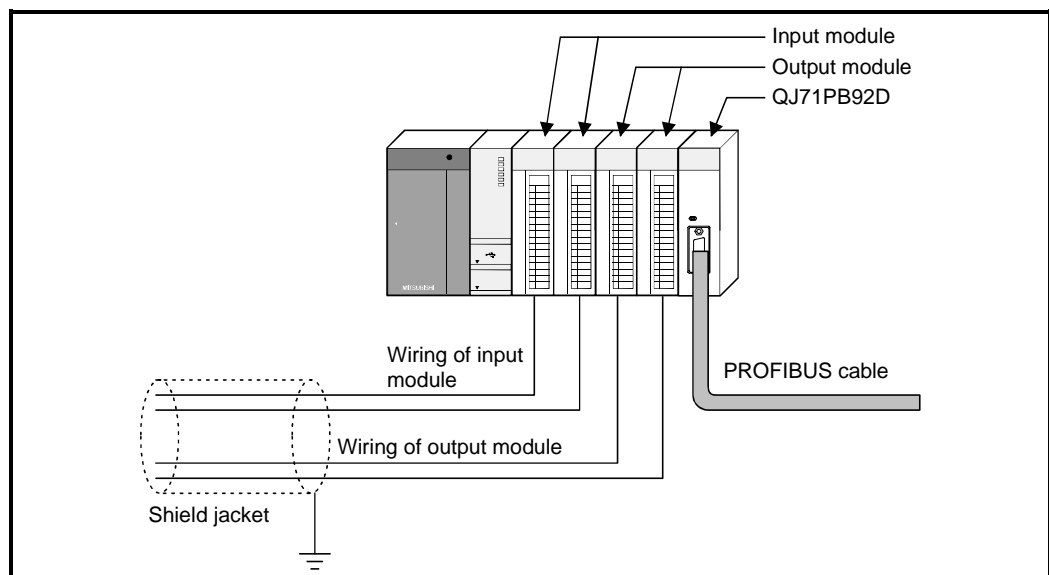

#### (3) Grounding

- (a) When using the QJ71PB92D, ground the FG and LG terminals of the power supply module of the programmable controller.
- (b) Grounding the module and other device with the same FG terminal may apply noise through the FG terminal and result in a communication error. If this error occurs, disconnect the FG terminal from the module.

## 5.6 Maintenance and Inspection

For the QJ71PB92D, eliminate the check of cable connection and looseness and do not include it as an inspection item. Otherwise, follow the inspection item instructions in the QCPU User's Manual (Hardware Design, Maintenance and Inspection) to always use the system in good condition.

### **DANGER**

- Before cleaning, be sure to shut off all phases of the external power supply used by the system.  
If you do not switch off the external power supply, it will cause failure or malfunction of the module.

### **CAUTION**

- Never disassemble or modify the module.  
This may cause breakdowns, malfunctioning, injury and/or fire.
- Be sure to shut off all phases of the external power supply before mounting or removing the module. If you do not switch off the external power supply, it will cause failure or malfunction of the module.
- Do not touch the conductive area or the electronic parts of the module.  
Doing so may cause malfunctioning or breakdowns.

6. COMMUNICATION TIME

6.1 Bus Cycle Time

(1) When a single master station is used

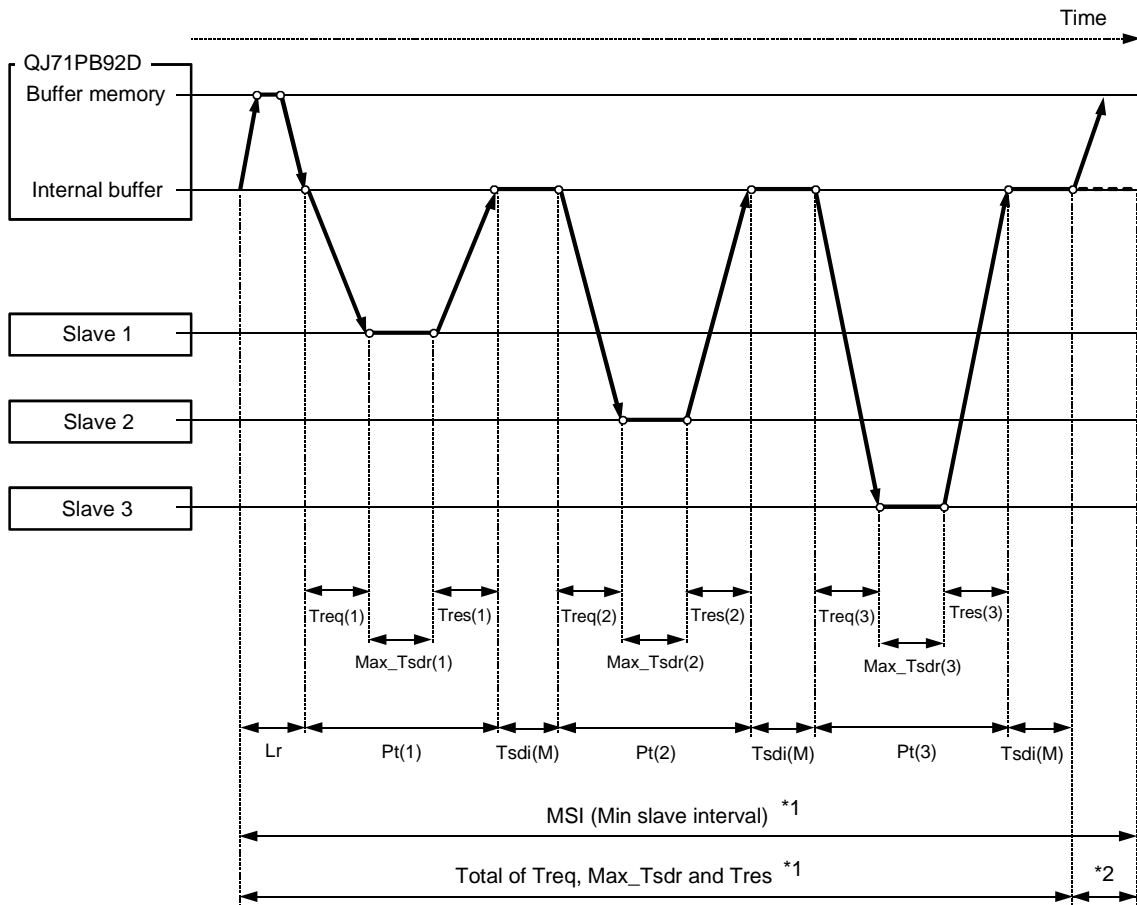

\*1 "MSI (Minimum polling cycle)" or "Total of Treq, Max\_Tsdr and Tres", whichever is greater, is Bc (Bus cycle time). (Refer to (1) (a).)

\*2 If "MSI (Minimum polling cycle)" is greater than "Total of Treq, Max\_Tsdr and Tres", the QJ71PB92D transfers data from the internal buffer to the buffer memory at intervals of the "MSI (Minimum polling cycle)".

(a) Bus cycle time (Bc) calculation formula

Calculate the bus cycle time (Bc) of the master station with the following expression.

The symbols within [] indicate units.

$$Bc[s] = \text{Max} (MSI, \sum_{i=1}^n (Pt_{(i)} + Tsdi_{(M)}) + Lr)$$

n = number of slave stations

Max (A, B) = A or B, whichever is greater

Item	Description
MSI[s]	Minimum polling cycle (Min. slave interval) *1
Pt(i)[s]	(Polling time of No. i station) = Treq(i) + Max_Tsdr(i) + Tres(i) • Treq(i)[s] = (Request transmission time of No. i station) = [(Number of bytes output to No. i station) + 9] × 11[bit] ÷ (transmission speed [bps]) • Max_Tsdr(i)[s] = (response time [TBit] of No. i station) *2, *3 ÷ (transmission speed [bps]) • Tres(i)[s] = (Response transmission time of No. i station) = [(Number of bytes input from No. i station) + 9] × 11[bit] ÷ (transmission speed [bps])
Tsdi(M)[s]	(Request/response processing time [TBit] of master station (QJ71PB92D)) *4 ÷ (transmission speed [bps])
Lr[s]	• For the QJ71PB92D (QJ71PB92D) (data refresh time) = (number of slave stations) × 150 × 10 <sup>-6</sup> • For the QJ71PB92V (QJ71PB92D-compatible function) (QJ71PB92V (92D-compatible)) (data refresh time) = 0.002 + (number of slave stations) × 150 × 10 <sup>-6</sup>

\*1 The value set on the "Master Settings" screen of GX Configurator-DP.

\*2 MaxTsdr value described in the GSD (DDB) file of the slave station.

\*3 [TBit] (Bit Time) is a unit that expresses the time required for 1-bit data transmission as "1".

The actual processing time differs as described below depending on the transmission speed.

[1.5Mbps]

$$1[T_{Bit}] = 1 \div (1.5 \times 10^6) = 0.667 \times 10^{-6}[s]$$

[12Mbps]

$$1[T_{Bit}] = 1 \div (12 \times 10^6) = 0.083 \times 10^{-6}[s]$$

\*4 Tsdi value described in the GSD (DDB) file of the QJ71PB92D.

The Tsdi value varies as described below depending on the transmission speed.

Refer to 3 for the unit [TBit].

Transmission speed	Request/response processing time of master station
9.6kbps, 19.2kbps, 93.75kbps, 187.5kbps	70TBit
500kbps	150TBit
1.5Mbps	200TBit
3Mbps	250TBit
6Mbps	450TBit
12Mbps	800TBit



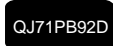

(b) Bus cycle time calculation example

An example of calculating the bus cycle time for the QJ71PB92D is explained below.

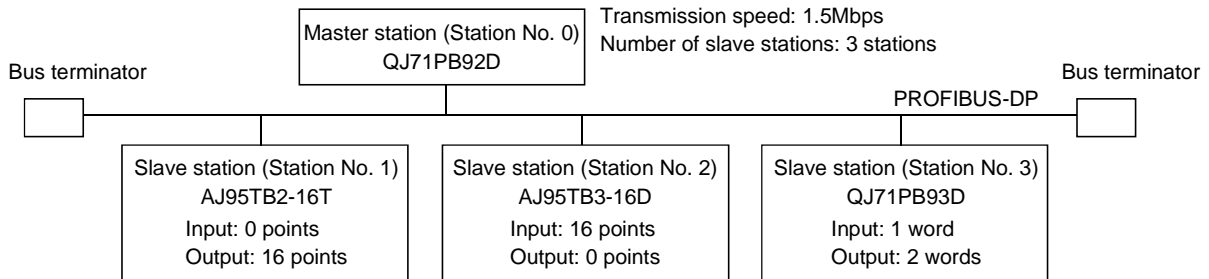

	AJ95TB2-16T	AJ95TB3-16D	QJ71PB93D
Output data size [byte]	2	0	4
Input data size [byte]	0	2	2

1) MSI[s] value

$$MSI[s] = 20 \times 100 \times 10^{-6} = 2.0 \times 10^{-3}$$

2) Pt(i)[s] value

Item	Slave station		
	AJ95TB2-16T (Station No. 1)	AJ95TB3-16D (Station No. 2)	AJ71PB93D (Station No. 3)
<b>1</b> Treq(i)[s]	$\{(2 + 9) \times 11\} / (1.5 \times 10^6)$ $= 0.081 \times 10^{-3}$	$\{(0 + 9) \times 11\} / (1.5 \times 10^6)$ $= 0.066 \times 10^{-3}$	$\{(4 + 9) \times 11\} / (1.5 \times 10^6)$ $= 0.095 \times 10^{-3}$
Response time [TBit] of No. i station	150	150	150
<b>2</b> Max_Tsdr(i)[s]	$150 / (1.5 \times 10^6) = 0.1 \times 10^{-3}$	$150 / (1.5 \times 10^6) = 0.1 \times 10^{-3}$	$150 / (1.5 \times 10^6) = 0.1 \times 10^{-3}$
<b>3</b> Tres(i)[s]	$\{(0 + 9) \times 11\} / (1.5 \times 10^6)$ $= 0.066 \times 10^{-3}$	$\{(2 + 9) \times 11\} / (1.5 \times 10^6)$ $= 0.081 \times 10^{-3}$	$\{(2 + 9) \times 11\} / (1.5 \times 10^6)$ $= 0.081 \times 10^{-3}$
Pt(i)[s] <b>(1 + 2 + 3)</b>	$0.081 \times 10^{-3} + 0.1 \times 10^{-3} + 0.066 \times 10^{-3} = 0.247 \times 10^{-3}$	$0.066 \times 10^{-3} + 0.1 \times 10^{-3} + 0.081 \times 10^{-3} = 0.247 \times 10^{-3}$	$0.095 \times 10^{-3} + 0.1 \times 10^{-3} + 0.081 \times 10^{-3} = 0.276 \times 10^{-3}$

3) Tsd(i)[s] value

Request/response processing time [TBit] of master station (QJ71PB92D)  
= 200

$$Tsd(i)[s] = 200 / (1.5 \times 10^6) = 0.13 \times 10^{-3}$$

4) Lr[s] value

$$Lr[s] = 3 \times 150 \times 10^{-6} = 0.45 \times 10^{-3}$$

From the values in previous page 2) to 4)

Values obtained at 2)      3)      4)

$$\begin{aligned} \sum_{i=1}^3 (Pt(i) + Tsd(i)) + Lr &= \{(Pt(1) + Tsd(i)) + (Pt(2) + Tsd(i)) + (Pt(3) + Tsd(i))\} + Lr \\ &= \{(0.377 \times 10^{-3}) + (0.377 \times 10^{-3}) + (0.406 \times 10^{-3})\} + 0.45 \times 10^{-3} \\ &= 1.16 \times 10^{-3} + 0.45 \times 10^{-3} \\ &= 1.61 \times 10^{-3} \end{aligned}$$

Hence, the bus cycle time (Bc) value is as follows.

Value obtained at 1)

$$\begin{aligned}
 Bc[s] &= \text{Max} \left( MSI, \sum_{i=1}^3 (Pt(i) + Tsdi(M)) + Lr \right) \\
 &= \text{Max} (2.0 \times 10^{-3}, 1.61 \times 10^{-3}) \\
 &= 2.0 \times 10^{-3} [s]
 \end{aligned}$$

(2) When multiple master stations

The bus cycle time (Bc) can be obtained by the following calculation formula when there are multiple master stations on the same network:

$$TBc[s] = \sum_{i=1}^n Bc(i)$$

n = Number of master stations

Bc = Bus cycle time of each master station (Refer to (1) in this section)

The following shows an example where two master stations exist on the same network.

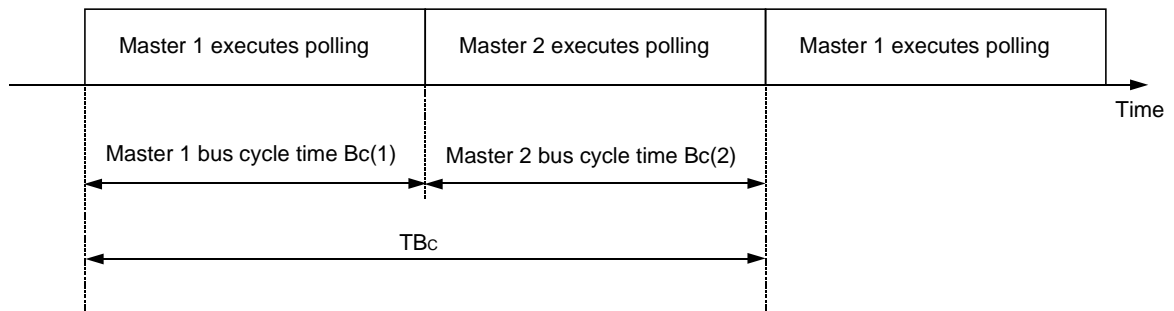

## 6.2 Transmission Delay Time

The transmission delay time of the input data and output data varies depending on the separation prevention setting. The calculation expressions for the transmission delay time are given in (1) and (2).

The following are used in the calculation expressions in (1) and (2).

Bc: Bus cycle time<sup>\*1</sup>

Scan: Scan time

\*1 When multiple master stations exist on the same network, replace Bc with TBc.

## (1) Without separation prevention function

A transmission delay time when I/O data is read/written using the automatic refresh setting (without separation prevention function), MOV instruction or FROM/TO instruction.

## (a) Output data delay time

Item	Transmission delay time
Normal value	$Bc \times 1.5$
Max. value	$Bc \times 2$

## (b) Input data delay time

Item	Transmission delay time
Normal value	$Scan + Bc$
Max. value	$Scan + Bc \times 2$

## (2) With separation prevention function

A transmission delay time when I/O data is read/written using the automatic refresh setting (with separation prevention function) or dedicated instruction.

## (a) Output data delay time

Item	Conditions	Transmission delay time
Normal value	—	$Scan + Bc$
Max. value	$Scan \times 2 \leq Bc$	$Bc \times 3$
	$Scan \times 2 > Bc$	$Scan \times 2 + Bc \times 2$

## (b) Input data delay time

Item	Conditions	Transmission delay time
Normal value	—	$Scan + Bc$
Max. value	$Scan \times 2 \leq Bc$	$Scan + Bc$
	$Scan \leq Bc < Scan \times 2$	$Scan + Bc \times 2$
	$Scan > Bc$	$Scan \times 3$

## 7. PROGRAMMING

The following shows the program examples used to execute the global control and execute the separation prevention function using the dedicated instruction during the communication in the Normal service mode (MODE 0) and Extended service mode (MODE E).

Before using the program examples introduced in this chapter in an actual system, fully check that there is no problem in control on the target system.

### (1) System configuration example

The following system configuration is used as an example for explanations in Sections 7.1 to 7.5.

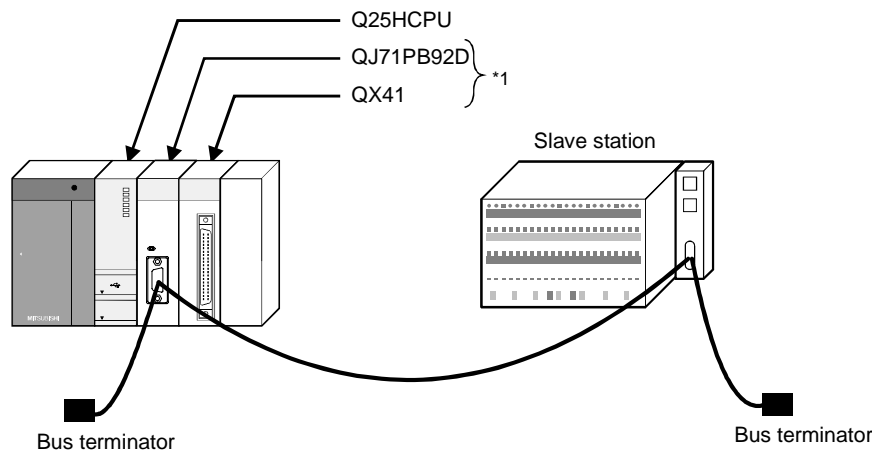

\*1 The modules are installed to the base unit in order from slot 0 as shown in the figure, and respective head I/O numbers shall be set as follows.

Slot	Type	Model name	Points	StartXY
0	PLC	Q25HCPU		
1	Intelli.	QJ71PB92D	32points	0000
2	Input	QX41	32points	0020
3				
4				

Module	Input signal	Output signal
QJ71PB92D	X0 to X1F	Y0 to Y1F
QX41	X20 to X3F	—

(2) Settings

(a) QJ71PB92D settings

Item		Description
FDL address (Station number)		FDL address 0
Transmission speed		1.5Mbps
I/O area for FDL address 1 (Buffer memory)	Input area	0 (0H)
	Output area	960 (3C0H)

(b) Slave station settings

Item		Description
FDL address (Station number)		FDL address 1
I/O data size	Input data size	1 word (2 bytes)
	Output data size	1 word (2 bytes)

(3) Usage status of input area (U0\G0 to U0\G959) and output area (U0\G960 to U0\G1919)

The following shows the usage status of the input and output areas.

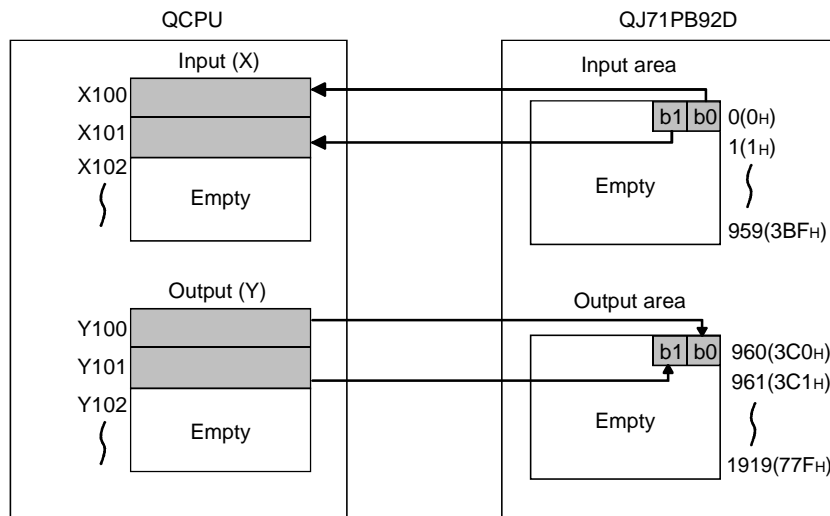

## (4) Assignment of devices in program examples

The program examples given in Sections 7.1 to 7.5 use the following device assignments.

## (a) Devices used by modules

## 1) QJ71PB92D

Device	Description	Device	Description
X0	Exchange start end signal	Y0	Exchange start request signal
X1	Communication trouble detection signal	Y1	Communication trouble detection signal reset
X2	Communication trouble area clear end signal	Y2	Communication trouble area clear request signal
	—	Y3	Communication trouble area type selection signal
X4	Global control end signal	Y4	Global control request signal
	—	Y0C	Dedicated instruction valid signal
X11	Operation mode change completion signal	Y11	Operation mode change request signal
X1B	Communication READY signal		—
X1D	Module READY signal		
X1F	Watchdog timer error signal		

## 2) QX41

Device	Description	Device	Description
X20	Exchange start command		—
X21	Communication trouble detection reset command		
X22	Communication trouble area clear command		
X23	Global control command		
X24	Operation mode change command		
X30 to X31	Data transmission command to slave stations		

## (b) Devices used by the user

Device	Description	Device	Description
M1	Communication trouble detection reset flag	M101	Dedicated instruction execution enable flag
M2	Communication trouble area clear flag	M400	Initial setting execution command
M3	Global control request flag	Z0	Index register for input start address
M4	Operation mode change request flag	Z1	Index register for output start address
M5	Operation mode change result read flag	SM402	After RUN, ON for 1 scan only
M100	Normal communication flag		—

## (c) Devices used as automatic refresh or buffer memory read target

Device	Description	Device	Description
X100 to X101	Transfer destination for data input from slave stations	D101	Storing output start address
Y100 to Y101	Transfer destination for data output to slave stations	D200	Storing input data
D0	Storing operation mode change result	D300	Storing data output to slave stations
D1	Storing current operation mode	D1000 to D1004	Storing trouble information storage device data
D100	Storing input start address		—

### 7.1 Communication Using Automatic Refresh Setting

The following shows the setting and program example used when the I/O data is read/written using the automatic refresh setting.

The automatic refresh is set in GX Configurator-DP.

This section gives setting examples for automatically refreshing I/O data for each slave station.

The setting method varies depending on the version of GX Configurator-DP as described below.

Version	Reference
GX Configurator-DP Version 7.01B or later	Section 7.1.1
GX Configurator-DP Version 5 to 7.00A	Section 7.1.2
GX Configurator-DP Version 4	Section 7.1.3

#### 7.1.1 When using GX Configurator-DP Version 7.01B or later

The following explanation about the setting example is based on the use of GX Configurator-DP Version 7.01B.

For details of the automatic refresh setting, refer to Section 5.1.5.

- 1) In the "PLC and GX IEC Developer (GID) Settings" dialog box, enable the automatic refresh setting.  
 [PLC and GX IEC Developer (GID) Settings] Slave Specific Transfer: Select this.  
 [PLC and GX IEC Developer (GID) Settings] AutoRefresh (Update of CPU): Select this.

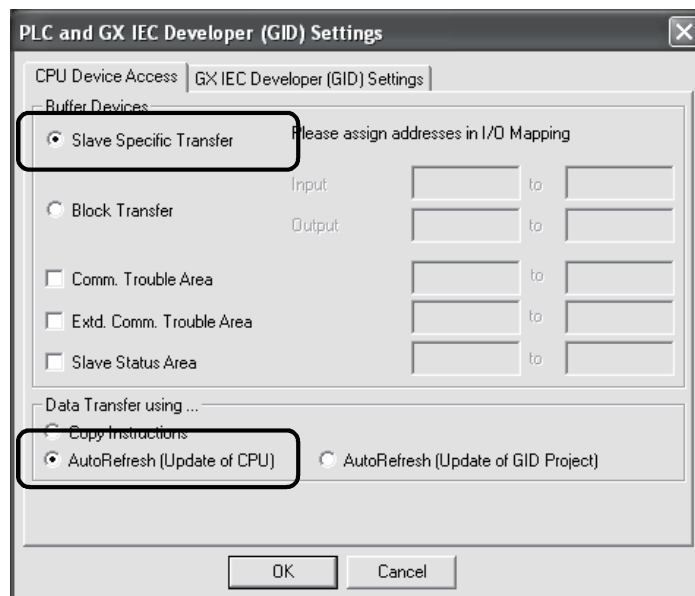

**POINT**

When a faster I/O data transfer is desired, select "Block Transfer" to auto-refresh the data collectively.

When using bit devices for Block Transfer, set the head numbers for I/O devices in units of 16 points.

- 2) When data separation during automatic refresh is to be prevented, check the Consistency in Master Settings.

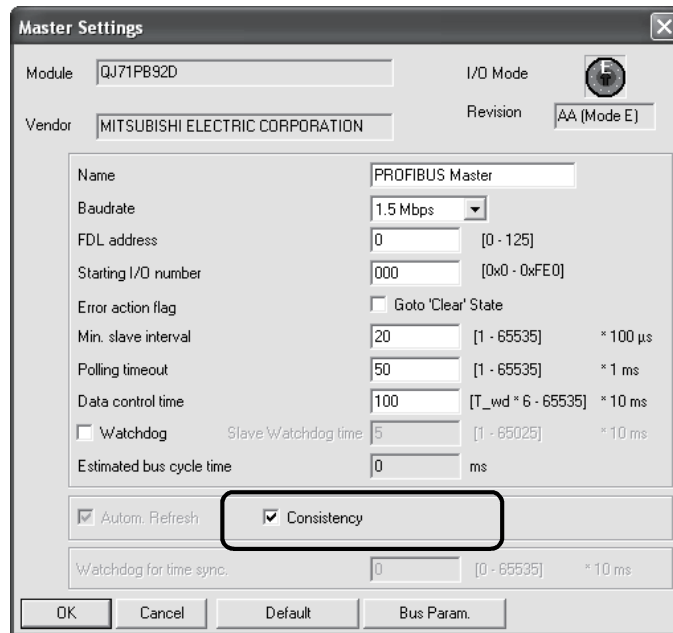

- 3) In the I/O Mapping dialog box, set devices used for automatic refresh.

[I/O Mapping]: Make settings under Buffer MIT-Address.

The refresh point settings are not required because GX Configurator-DP automatically calculates from the slave parameters.

When the devices set to the input and output are bit devices, set their head numbers in increments of 16 points.

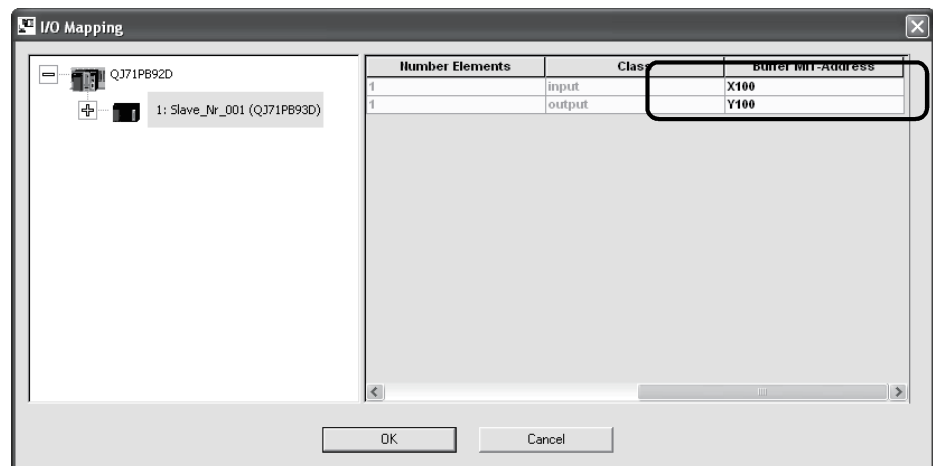



- 4) Write the project file (\*.DP2) of GX Configurator-DP, where the master parameters, slave parameters and automatic refresh parameter have been set, to the CPU module.

Select [Online] → [Transfer] → [Download to Module].

In the following window, click the **Yes** button.

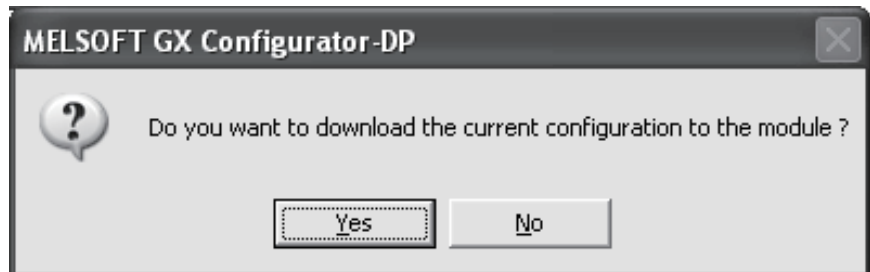
**POINT**

When the automatic refresh parameter are written to the CPU module using this package during GX Developer start-up, they are not displayed in "Read from PLC" or "Delete PLC data" and other file list of GX Developer.

Therefore, update the file list using the "Refresh view" button on the "Read from PLC" or "Delete PLC data" screen of GX Developer.

- 5) After writing the project file (\*.DP2) of GX Configurator-DP, reset the CPU module.

## 7.1.2 When using GX Configurator-DP Version 5 to 7.00A

The following explanation about the setting example is based on the use of GX Configurator-DP Version 7.00A.

- 1) Make the automatic refresh setting in the master parameters.

[Master Settings] Autom. Refresh: Check.

When executing separation prevention in the automatic refresh mode, check Consistency.

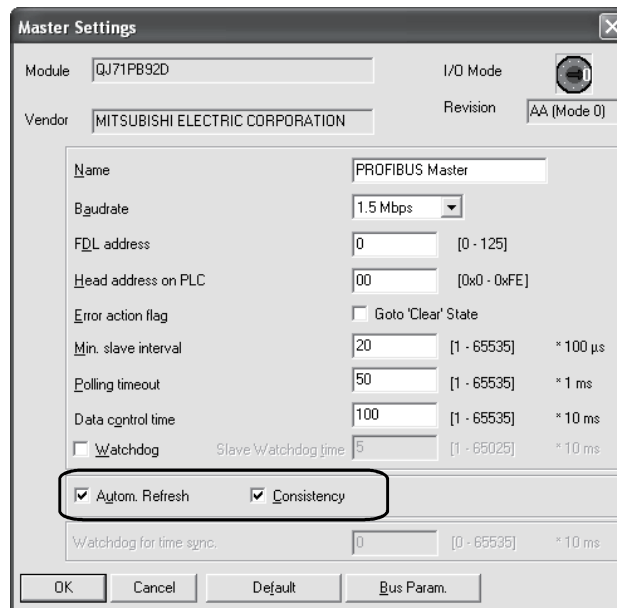

- 2) Set the devices used for automatic refresh in the slave parameters.  
[Slave Parameter Settings]: Set the devices to Addresses in MELSEC CPU Memory.

The refresh point settings are not required because GX Configurator-DP automatically calculates from the slave parameters.

When the devices set to the input and output are bit devices, set their head numbers in increments of 16 points.

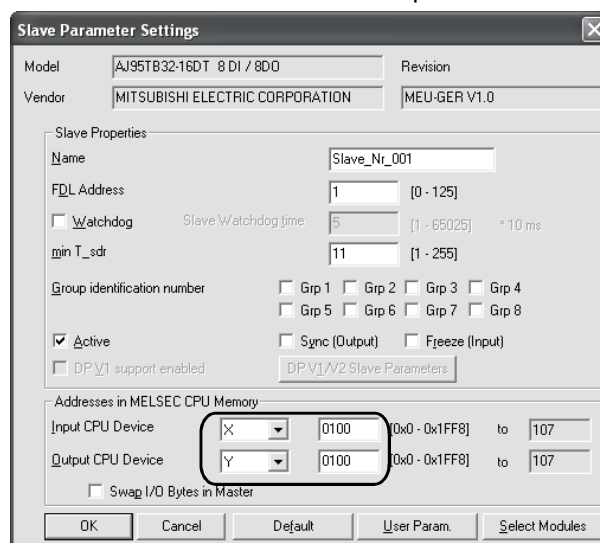

- 3) Enable the automatic refresh settings made in the slave parameters. Open [AutoRefresh Setting] in the [Setup] menu. As the following screen appears, check Slave Specific Transfer.

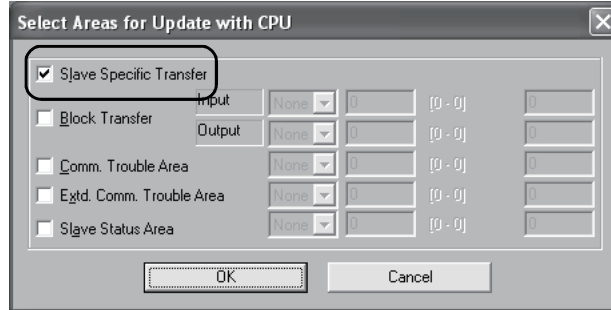
**POINT**

When a faster I/O data transfer is desired, select "Block Transfer" to auto-refresh the data collectively.

At this time, the automatic refresh setting preset with the slave parameters is disabled.

When the I/O devices set for Block Transfer are bit devices, set their head numbers in increments of 16 points.

- 4) Write the project file (\*.DP2) of GX Configurator-DP, where the master parameters, slave parameters and automatic refresh parameter have been set, to the CPU module. Open [Access Master Module] in the [Action] menu. As the following screen appears, check Update Autorefresh and click the **Download** button.

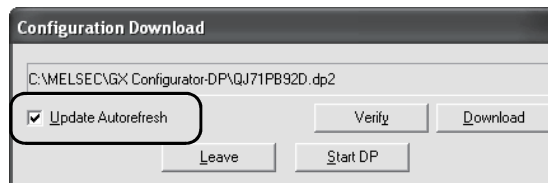
**POINT**

When the automatic refresh parameter are written to the CPU module using this package during GX Developer start-up, they are not displayed in "Read from PLC" or "Delete PLC data" and other file list of GX Developer.

Therefore, update the file list using the "Refresh view" button on the "Read from PLC" or "Delete PLC data" screen of GX Developer.

- 5) After writing the project file (\*.DP2) of GX Configurator-DP, reset the CPU module.

7.1.3 When using GX Configurator-DP Version 4

- 1) Make the automatic refresh setting in the master parameters.  
 [Master Settings] Autom. Refresh : Check  
 When executing separation prevention in the automatic refresh mode, check Consistency.

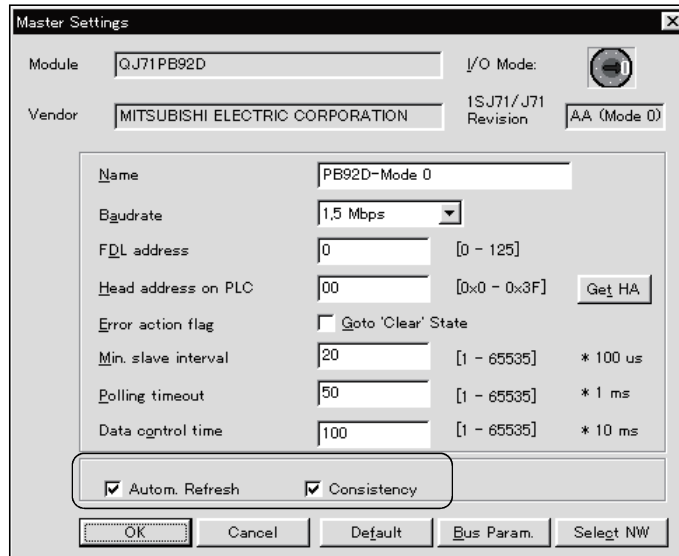

- 2) In the slave parameters, set the devices and head numbers used for automatic refresh.  
 Make settings using [Slave Parameter Settings]: Addresses in MELSEC CPU Memory. You need not set the numbers of refresh points since they are automatically calculated by GX Configurator-DP from the slave parameters.  
 When the devices set for input and output are bit devices, set the head numbers in increments of 16 points.

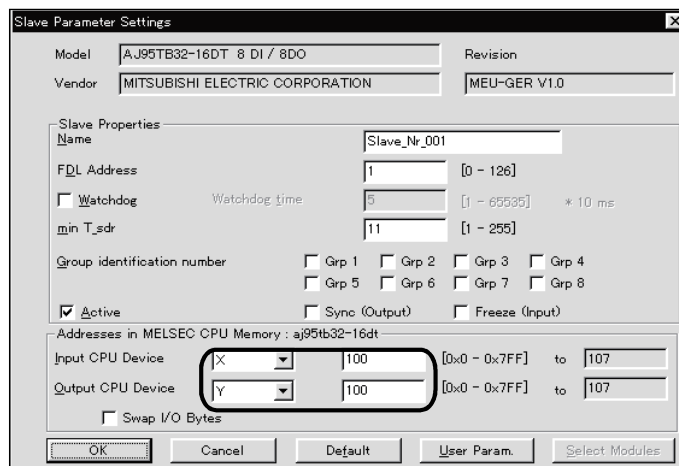

- 3) In the [Tools] menu, open [Profibus Configuration Utility].  
In the PROFIBUS Configuration Utility main menu select File/New to create a new IPARAM configurator project or File/Open to open an existing project. Enter the file name for a new project or select an existing project from the browse list.

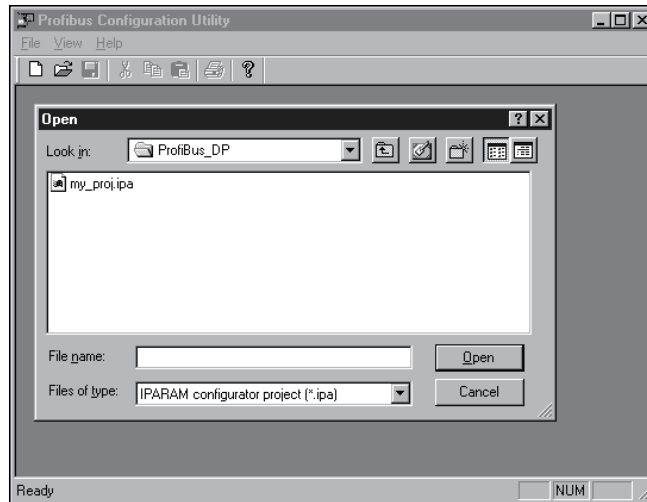

- 4) Before starting the communication with the programmable controller an entry in the network configuration database must be selected. Right-click on the project window to open the context menu and select [Select Network] to open the Select Network Index dialog.

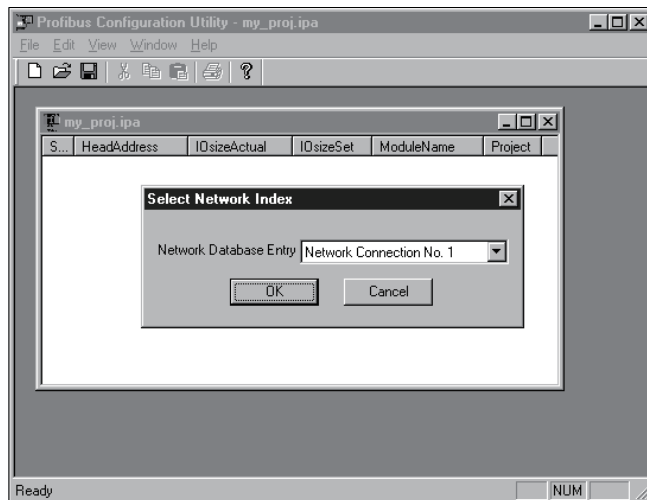

- 5) Right-click on the project window to open the context menu and select [Scan Rack] to obtain the list of boards in the rack.

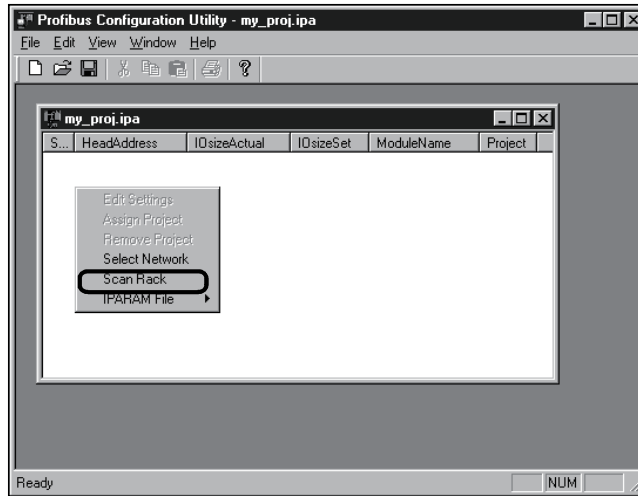

- 6) The information obtained from the CPU module contains slot, head address, the actual IO length of the module as well as a preset IO length and module name.

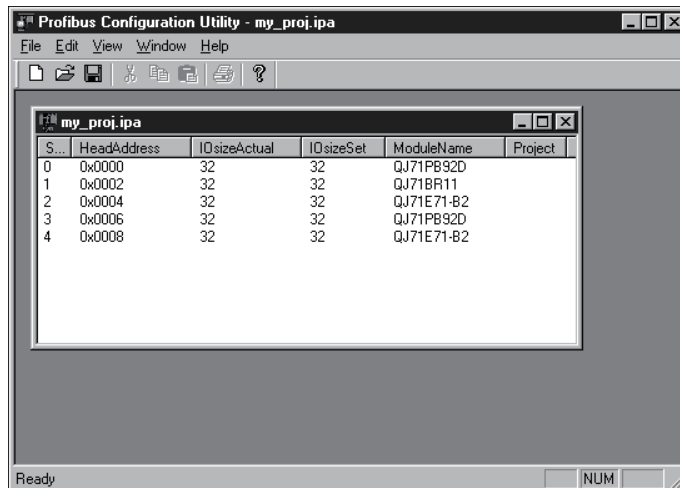

- 7) You have to assign a GX Configurator file to each master, for which you intend to include autorefresh settings in the IPARAM file.  
Right-click on a DP master entry to select [Assign Project].  
(The menu item Remove Project removes the assignment of a GX Configurator file to a master.)

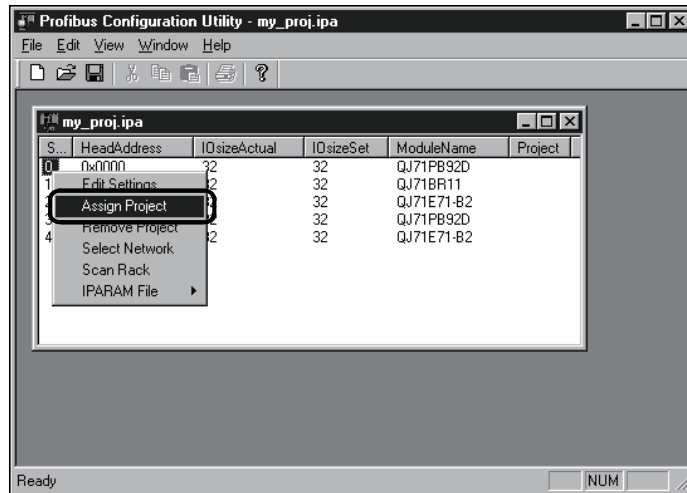

- 8) In the file browser dialog box, select a GX Configurator-DP file to be assigned to the selected DP master.

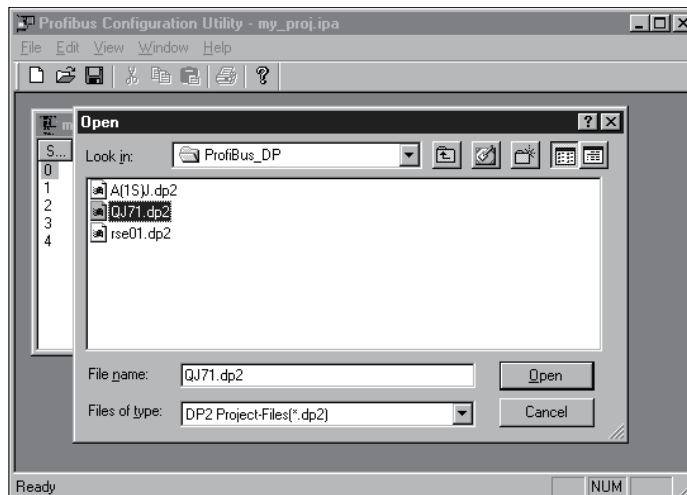

9) Right-click on a DP master entry to select [Edit Settings].

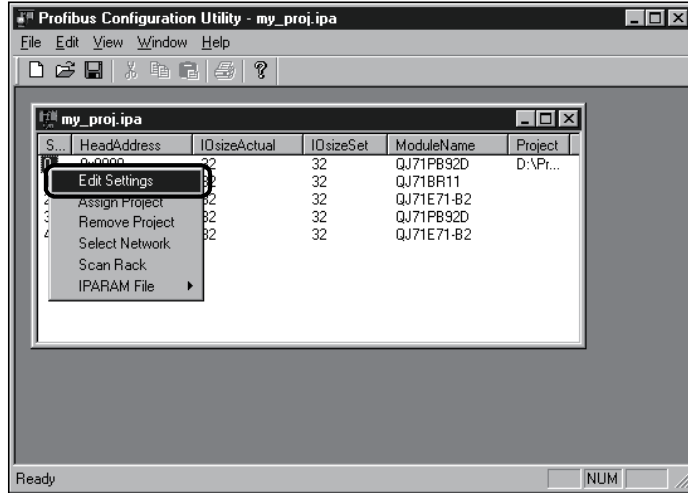

10) The autorefresh settings editor dialog box appears. Check Slave Specific Transfer.

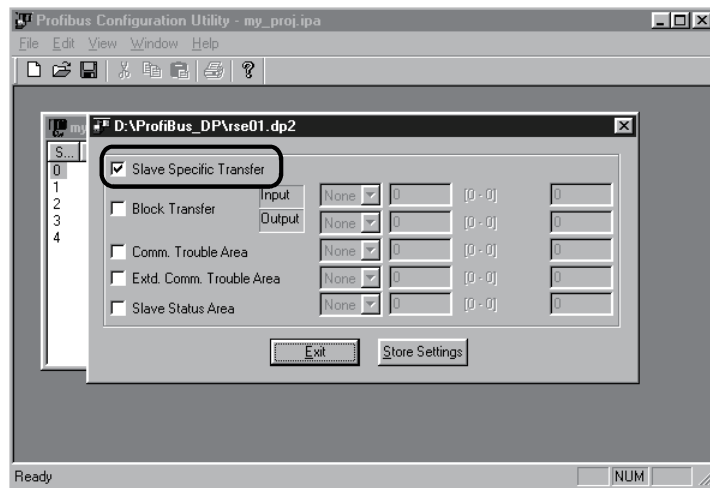

**POINT**

When a faster I/O data transfer is desired, select "Block Transfer" to auto-refresh the data collectively.

At this time, the auto refresh setting preset with the slave parameters is disabled.

When the I/O devices set for Block Transfer are bit devices, set their head numbers in increments of 16 points.



- 11) Choose [IPARAM File] → [Upload to PLC] from the context menu and write the IPARAM parameters to the programmable controller CPU.

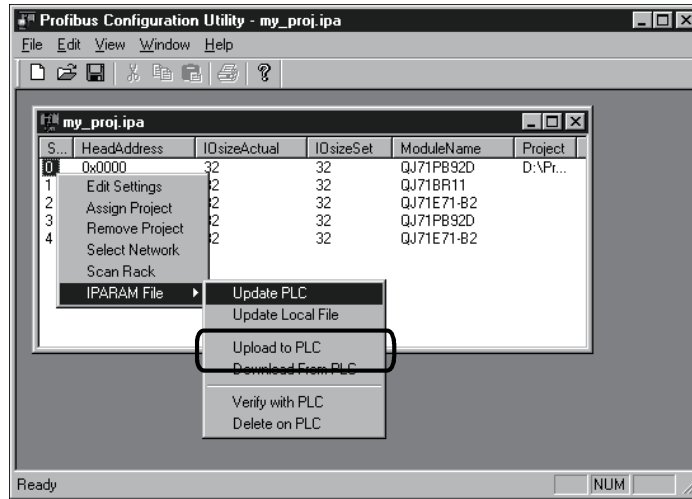

#### POINT

When IPARAM is written to the CPU module using this package during GX Developer start-up, it is not displayed in "Read from PLC" or "Delete PLC data" and other file list of GX Developer.

Therefore, update the file list using the "Refresh view" button on the "Read from PLC" or "Delete PLC data" screen of GX Developer.

- 12) After setting the IPARAM parameters, reset the CPU module.

7.1.4 Program example

When the automatic refresh function is used, the read/write program is not required for the input/output areas.

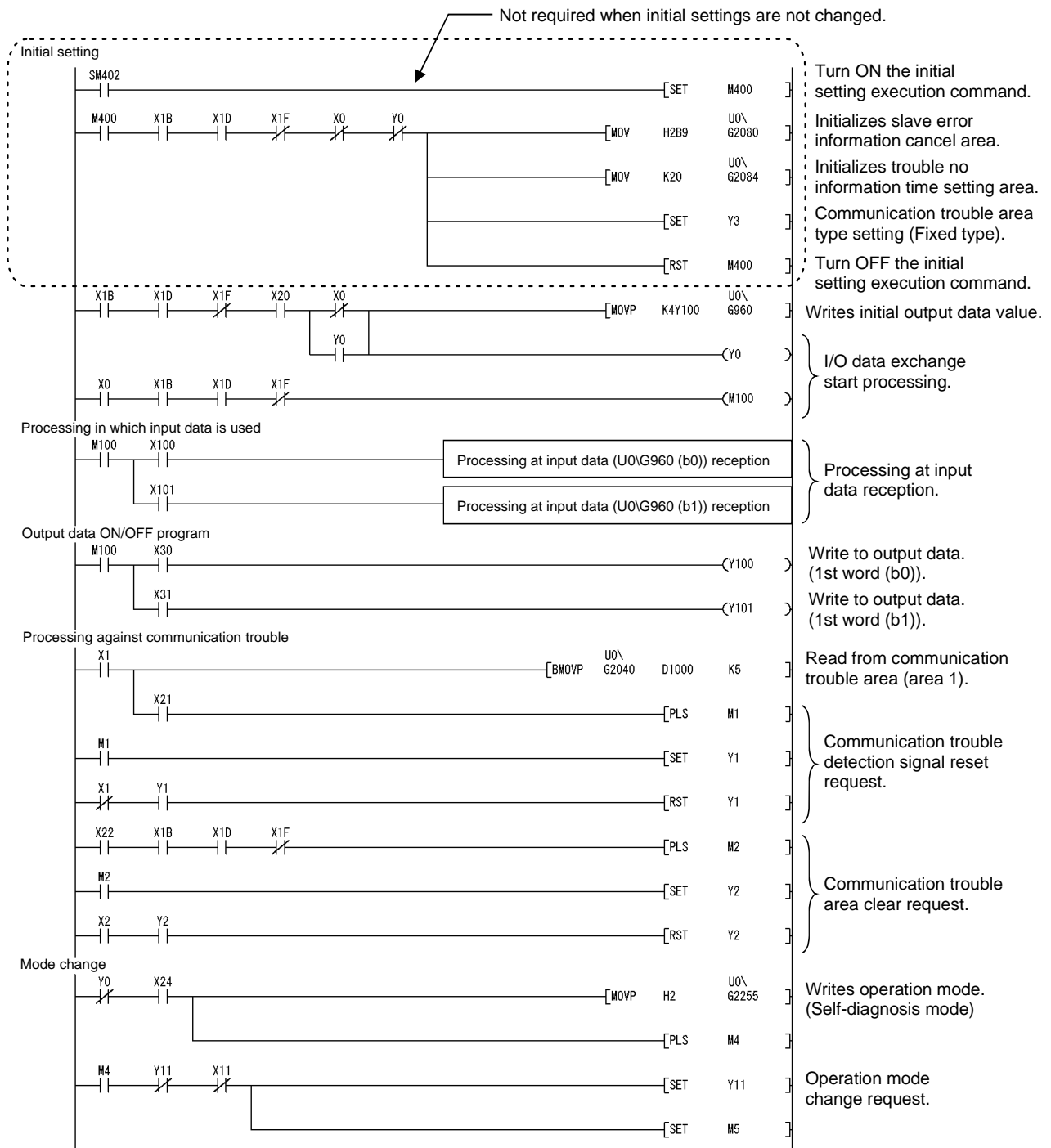

(To the next page)

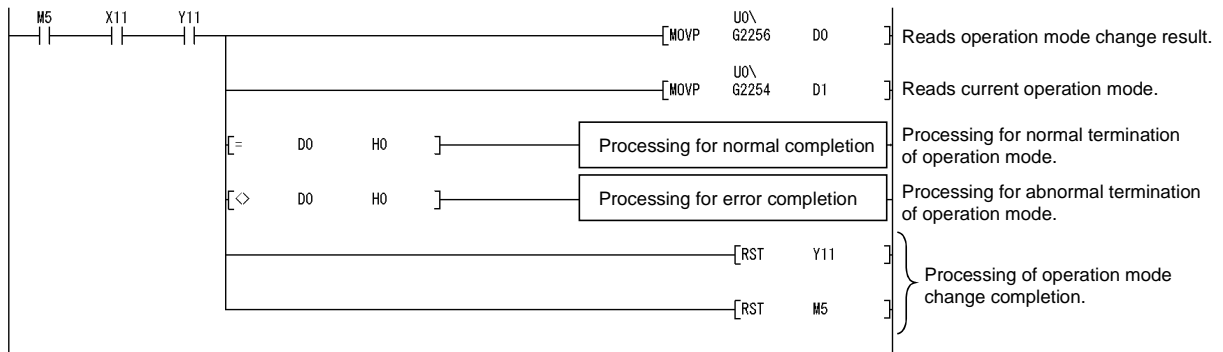

**POINT**

When changing the operation mode using this program example, do not change the operation mode from GX Configurator-DP.

7.2 Communication Using Dedicated Instruction

The following shows the program example used when the I/O data is read/written using the dedicated instruction for separation prevention in the Normal service mode (MODE 0).

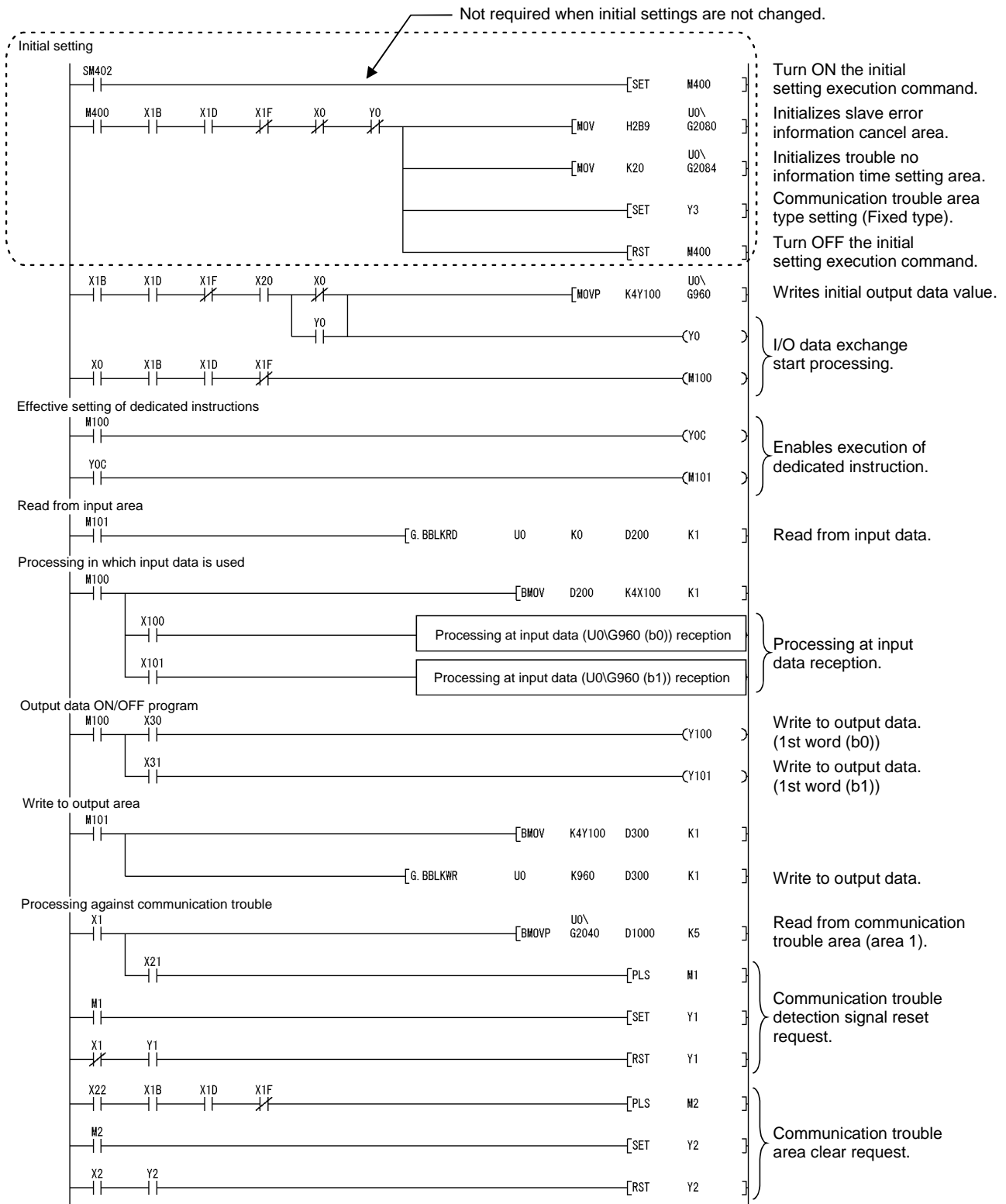

(To the next page)

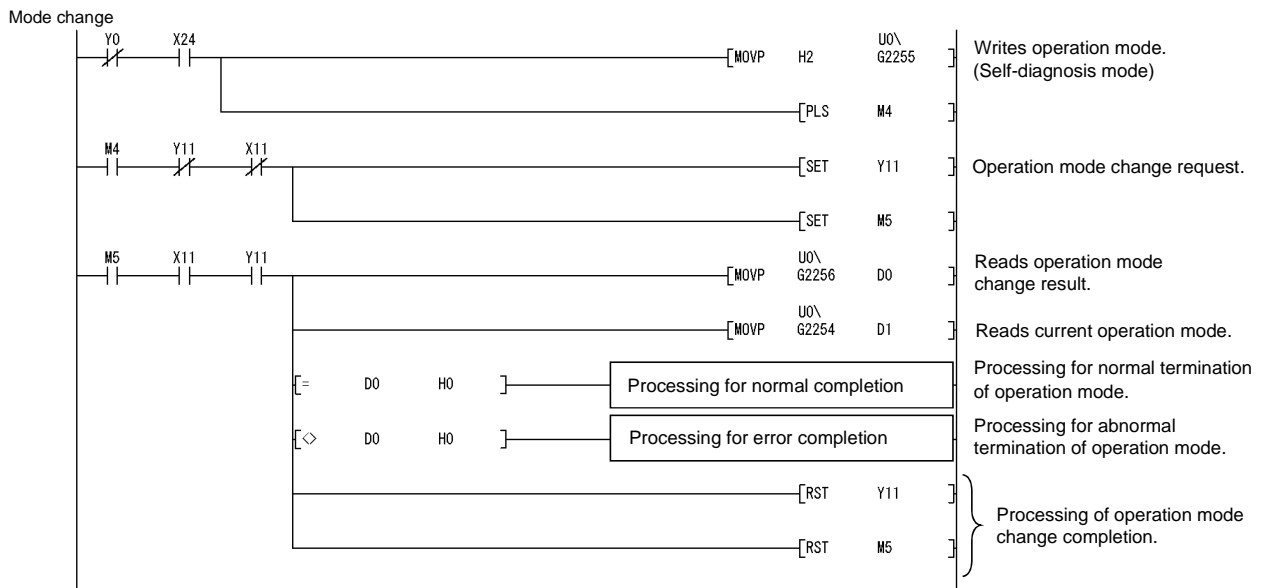

**POINT**

- (1) When changing the operation mode using this program example, do not change the operation mode from GX Configurator-DP.
  - (2) Confirm that Consistency is disabled with Autom. Refresh enabled. (Refer to Section 5.1.2)
- When the automatic refresh and data separation prevention functions are enabled, dedicated instructions are not processed.

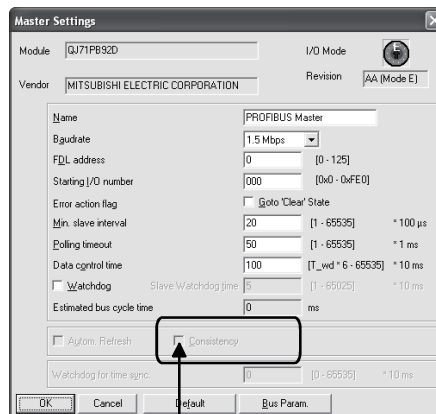

Make sure the box is unchecked.

7.3 Normal Service Mode (MODE 0) Using MOV Instruction

The following shows the program example used when the I/O data is read/written using the MOV instruction in the Normal service mode (MODE 0).

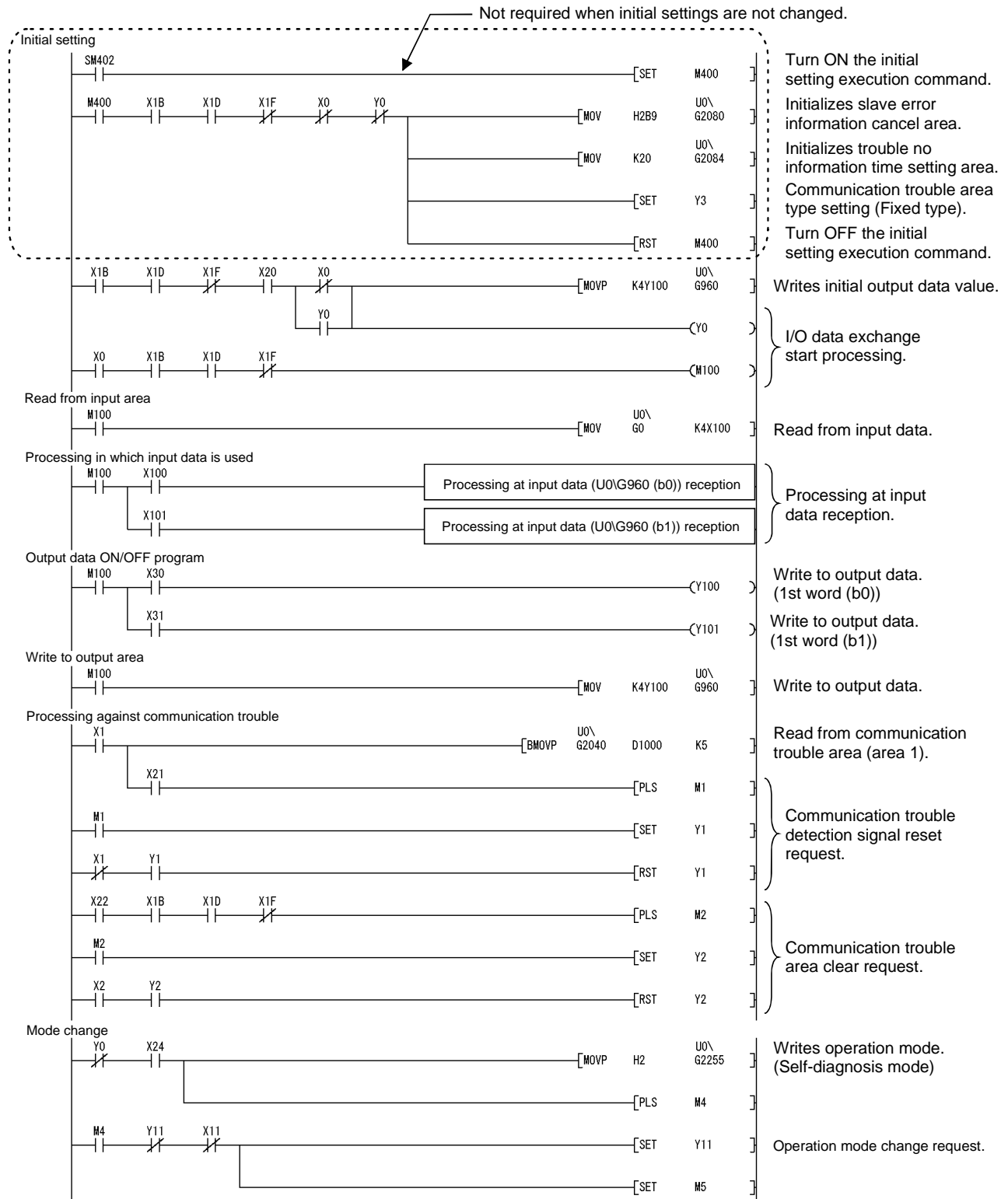

(To the next page)

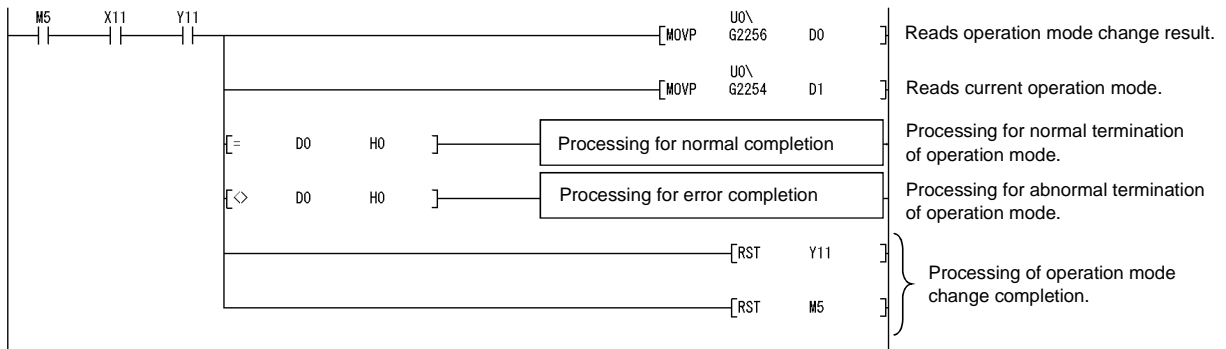

**POINT**

When changing the operation mode using this program example, do not change the operation mode from GX Configurator-DP.

7.4 Extended Service Mode (MODE E) Using MOV Instruction

The following shows the program example used when the I/O data is read/written using the MOV instruction in the Extended service mode (MODE E).

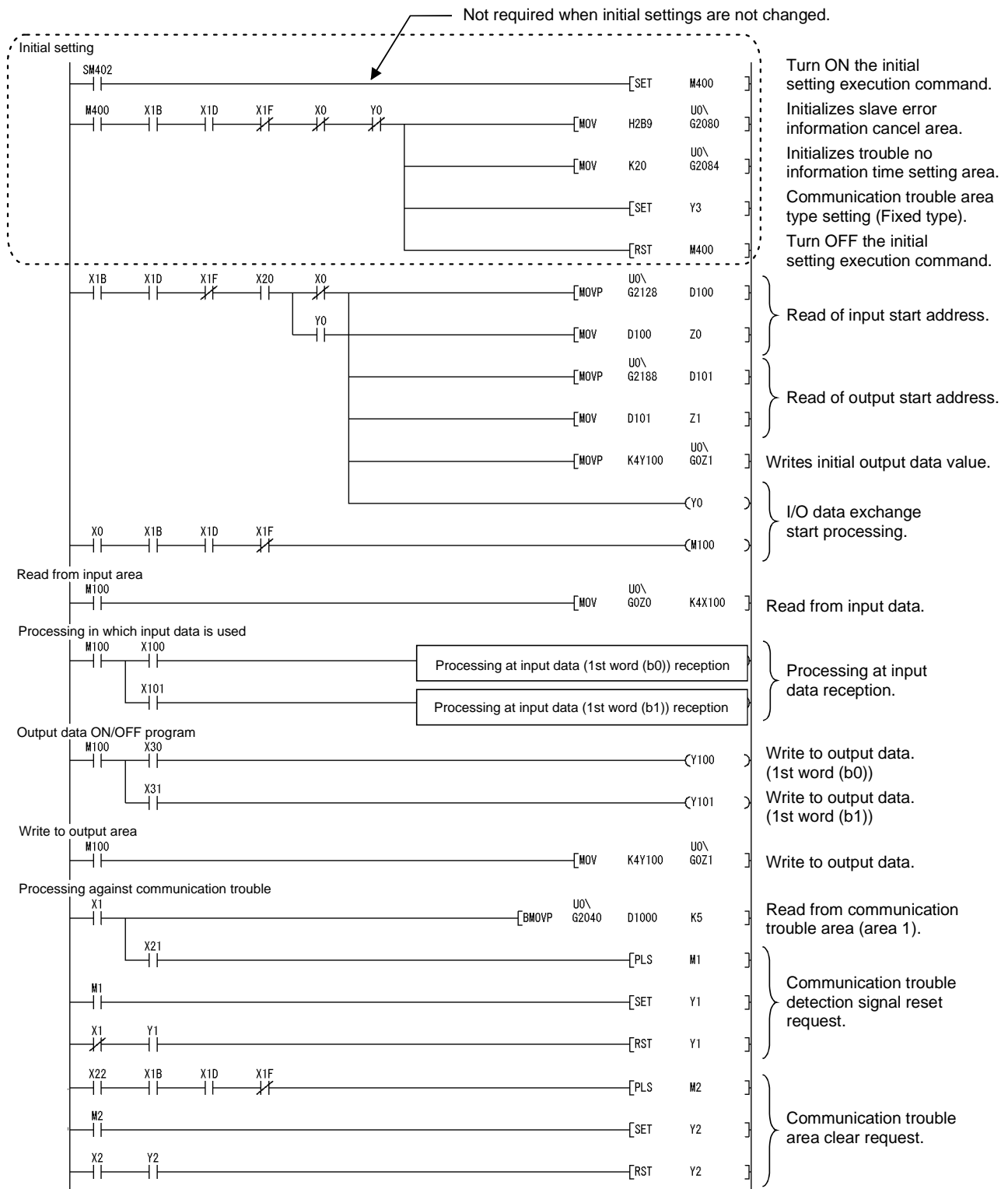

(To the next page)



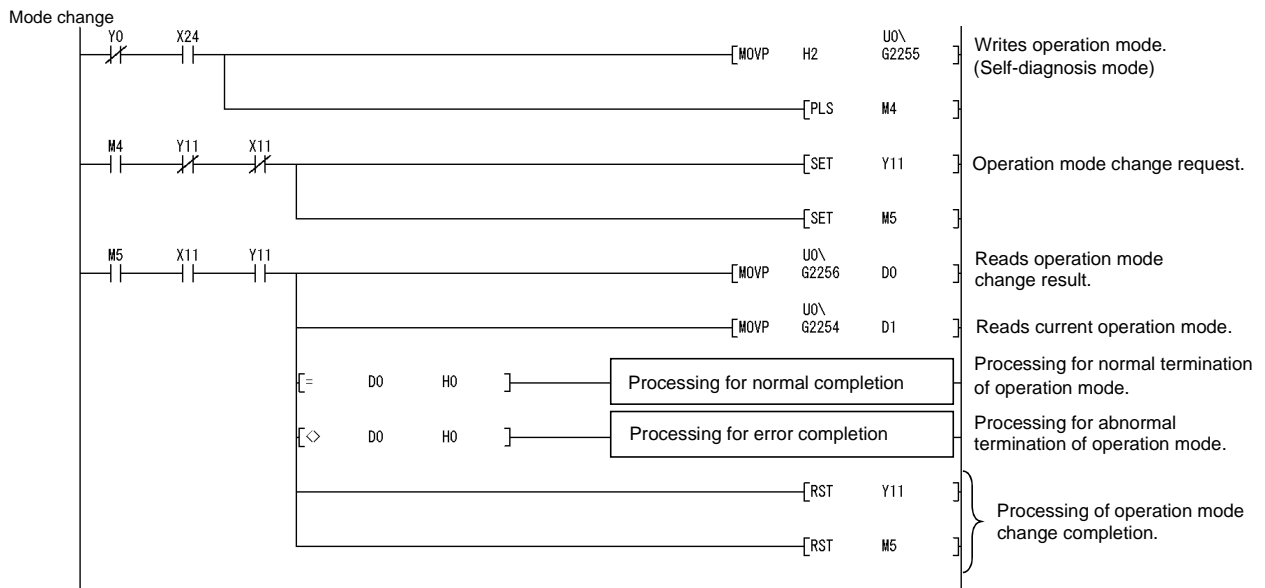

**POINT**

When changing the operation mode using this program example, do not change the operation mode from GX Configurator-DP.

7.5 Execution of Global Control

The following shows the program example added when the global control is executed. The operation mode and I/O data read/write methods are not related to this program example.

Use of global control function

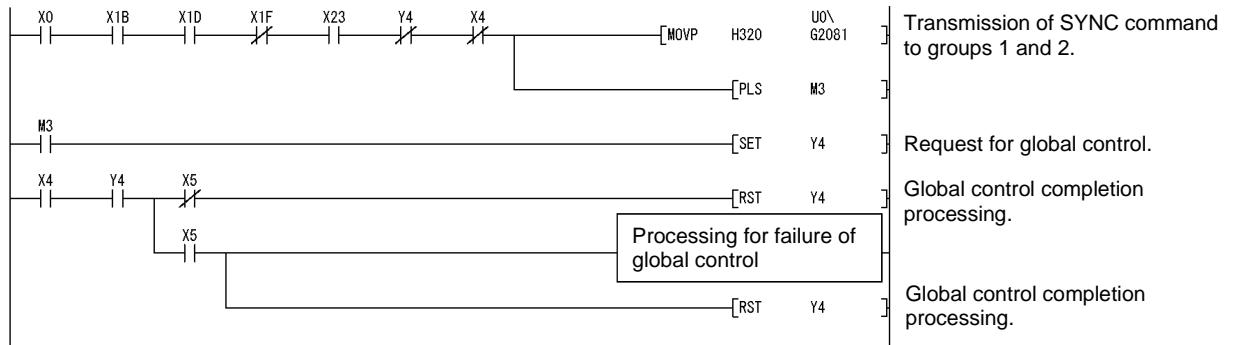

## 8. DEDICATED INSTRUCTIONS

A "dedicated instruction" is defined as an instruction designed to make programming easy for use of the intelligent function module functionality.

This chapter describes the dedicated functions available for the QJ71PB92D.

### 8.1 Dedicated Instruction List and Available Devices

#### (1) List of dedicated functions

The following list shows the dedicated instructions available for the QJ71PB92D.

Dedicated instruction	Description	Reference
BBLKRD	Reads data from the buffer memory of a specified module, ensuring data separation prevention.	Section 8.2
BBLKWR	Writes data to the buffer memory of a specified module, ensuring data separation prevention.	Section 8.3

#### (2) Available devices

The following devices are available for the dedicated instructions:

Internal devices		File register	Constant <sup>*1</sup>
Bit	Word		
v	T,ST,C,D,W	R,ZR	K,H

\*1 Available devices are given in each of the Constant field.

#### (3) Precautions when executing dedicated instructions

##### (a) CPU module usable for dedicated instructions

For execution of dedicated functions, use a QCPU whose first 5 digits of the serial No. are "02092" or later.

##### (b) Before executing a dedicated instruction

###### 1) Turn ON the Dedicated instruction valid signal (Y0C)

Before executing a dedicated instruction, turn ON the dedicated instruction valid signal (Y0C).

Attempting to execute a dedicated instruction with the dedicated instruction valid signal (Y0C) OFF will result in non-processing (non-execution).

###### 2) Check that Consistency is disabled with Autom. Refresh enabled.

If the automatic refresh and data separation prevention functions are enabled, use of dedicated instructions is not allowed. (They are not processed.)

Dedicated instructions are executable if the data separation prevention function is disabled in the automatic refresh setting. (Refer to Section 5.1.2)

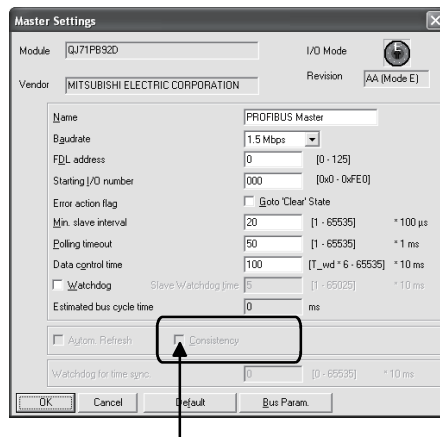

Make sure the box is unchecked.

- (c) **Using the BBLKRD and BBLKWR instructions in pairs**  
 The BBLKRD and BBLKWR instructions must be used in pairs, and must be always executed once for each in one sequence scan. (Refer to Section 7.4.)  
 Even if either of input data reading or output data writing is not necessary, use dummy input or output data to be read or written with the BBLKRD or BBLKWR instruction.  
 Using only one of the BBLKRD and BBLKWR instructions causes a longer transmission delay time.
- (d) **Execution timing**  
 Dedicated instructions are not processed while the QJ71PB92D is executing the data separation prevention function. (Refer to Section 4.1.4.)  
 Therefore, in a program that is executed only once at the leading or trailing edge of the pulse, I/O data may not be read or written.
- (e) **Transmission delay time when using a dedicated instruction**  
 Use of the data separation prevention function increases the transmission delay time. (Refer to Section 6.2)

8.2 G.BBLKRD

Set data	Usable devices								
	Internal device (System, user)		File register	Link direct device J□□		Intelligent function module device U□\G□	Index register Z□	Constant K, H	Other
	Bit	Word		Bit	Word				
n1	—	○	—		—	—	○	—	
Ⓓ	—	○	—		—	—	—	—	
n2	—	○	—		—	—	○	—	

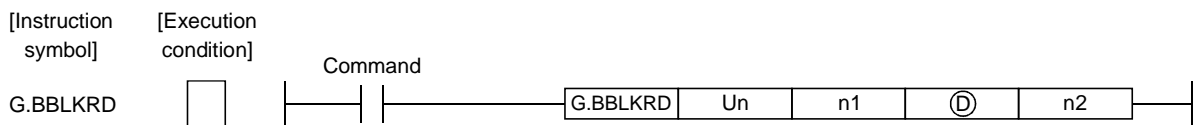

Setting Data

Setting data	Detail	Set Range	Data Type
Un	Module head I/O number of QJ71PB92D (Upper 2 digits of the I/O number in 3-digit notation)	0 to FEH	BIN16 bits
n1	Head address of data to be read	Specified device area	
Ⓓ	Head number of device in which read data is stored	Specified device area	Device name
n2	Number of reading data	1 to 960 words	BIN16 bits

Function

The data is read from the buffer memory of the specified module with the signals prevented from being separated.

Error

If the following event is encountered, an operation error will occur (Error code: 4101).

- A value out of the set range is set for the set data.
- The size of the data obtained by adding the number of data to be read to the head address of the data to be read exceeds the buffer memory size.
- The number of data to be read for the head address and subsequent is less than the number of reading data.

Program Example

Program for reading, with M10 = ON, the data amounting to 0 to 960 buffer memory addresses of QJ71PB92D (module head I/O number: 0) to D0 to D959 with the signals prevented from being separated.

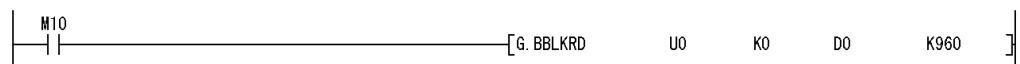

8.3 G.BBLKWR

Set data	Usable devices								
	Internal device (System, user)		File register	Link direct device J□□		Intelligent function module device U□\G□	Index register Z□	Constant K, H	Other
	Bit	Word		Bit	Word				
n1	—	○	—		—	—	○	—	
Ⓢ	—	○	—		—	—	—	—	
n2	—	○	—		—	—	○	—	

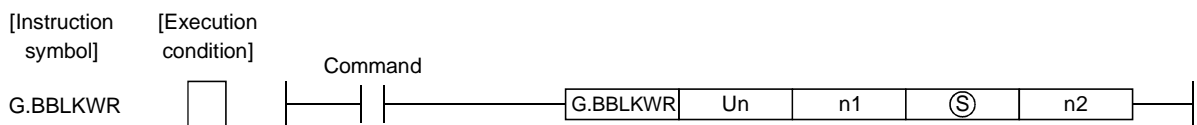

Setting Data

Setting data	Detail	Set Range	Data Type
Un	Module head I/O number of QJ71PB92D (Upper 2 digits of the I/O number in 3-digit notation)	0 to FEH	BIN16 bits
n1	Head address for data writing	Specified device area	
Ⓢ	Head number of device in which write data is stored	Specified device area	Device name
n2	Number of writing data	1 to 960 words	BIN16 bits

Function

The data is written to the buffer memory of the specified module with the signals prevented from being separated.

Error

If the following event is encountered, an operation error will occur (Error code: 4101).

- A value out of the set range is set for the set data.
- The size of the data obtained by adding the number of data to be written to the head address for data writing exceeds the buffer memory size.
- The number of data to be written for the head address and subsequent is less than the number of writing data.

Program Example

Program for writing, with M10 = ON, the data amounting to 0 to 960 buffer memory addresses of QJ71PB92D (module head I/O number: 0) to D0 to D959 with the signals prevented from being separated.

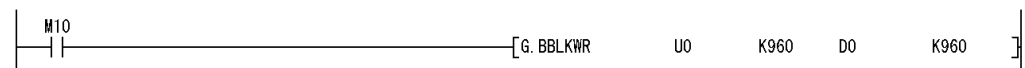

## 9. TROUBLESHOOTING

This chapter describes the troubleshooting of the QJ71PB92D.

### (1) Before troubleshooting

#### (a) Checking for a QCPU error

Before troubleshooting the QJ71PB92D, check that no errors have occurred on the QCPU.

If any error is identified, check the error details and take corrective actions.

QJ71PB92V  
(92D-compatible)

#### (b) When using the QJ71PB92V (QJ71PB92D-compatible function)

Check that the model name shown in the Module's Detailed Information window of GX Developer is "QJ71PB92D (92V)".

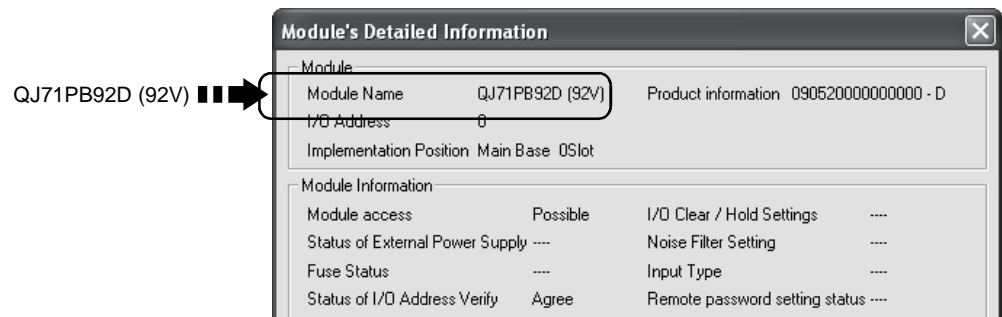

### (2) Troubleshooting flowchart

For the troubleshooting in Sections 9.1 to 9.3, refer to the following flowchart.

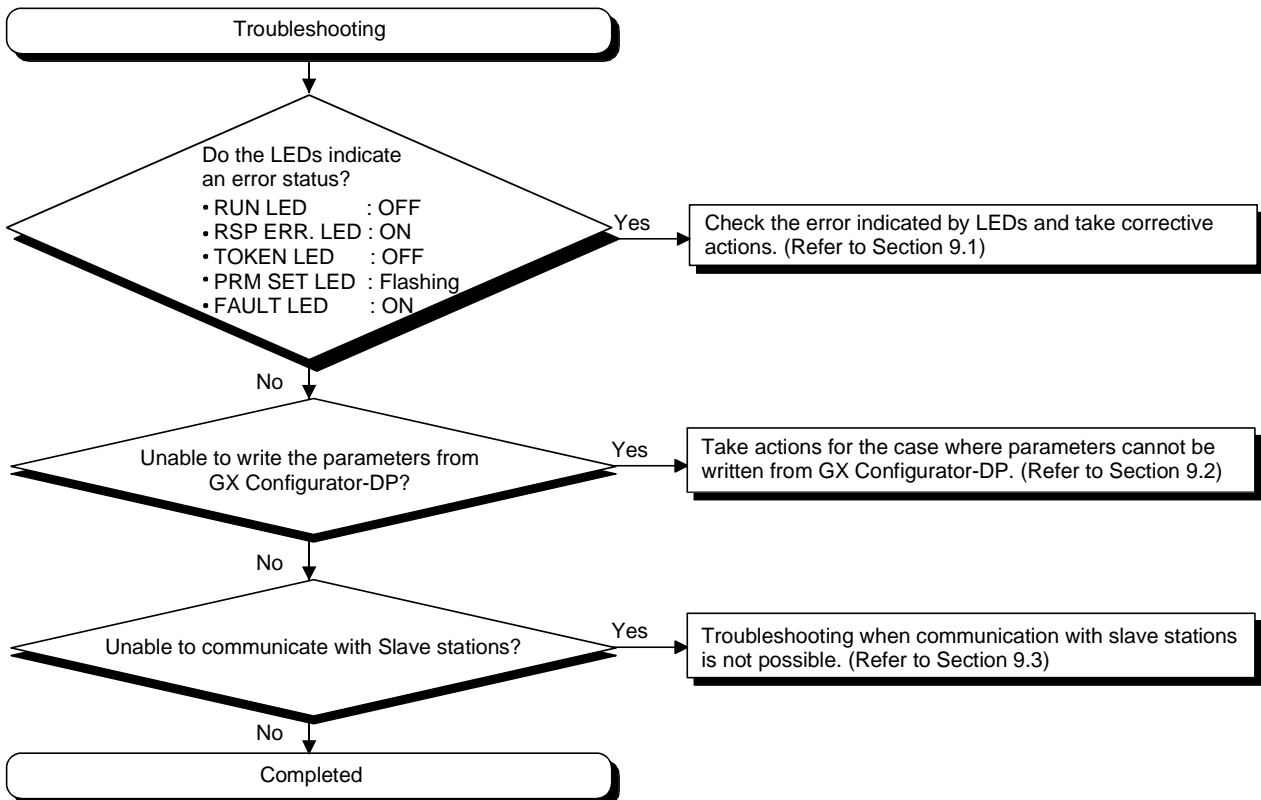

9.1 Error Check Using the LEDs and Corrective Actions

For troubleshooting in the Normal service mode (MODE 0) and Extended service mode (MODE E), the causes of errors, which are located using the status of LEDs, and measures against the errors are described below.

When the operation is in the Normal service mode (MODE 0) or Extended service mode (MODE E), the TEST LED indicator and PRM SET LED indicator of QJ71PB92D go off.

(1) For the QJ71PB92D

QJ71PB92D

LED	Status	Cause	Corrective Action
RUN	Goes OFF	The watchdog timer monitoring time is exceeded.	Please consult your local Mitsubishi representative, explaining a detailed description of the problem.
SD/RD	Flashes at a high rate	There is a slave station with which the initial communication cannot be performed (The parameter does not match the actual slave station).	Please consult your local Mitsubishi representative, explaining a detailed description of the problem.
TOKEN	Goes OFF	The token is not cycled. *1	<ul style="list-style-type: none"> <li>• Make sure that the PROFIBUS-DP cable is connected.</li> <li>• Check the terminating resistance set switch for correct function.</li> <li>• Make sure that the station addresses are not overlapped with each other.</li> <li>• Check if the station number does not exceed the HSA.</li> </ul>
PRM SET	Flashes	The parameter is not set.	Set the parameters using the GX Configurator-DP.
		The parameters in the flash ROM have been corrupted.	Refer to Section 9.5(1).
RSP ERR	Goes ON	A communication trouble occurs.	Read the trouble information from the communication trouble area (Un\G2040 to Un\G2079) of the buffer memory.
FAULT	Goes ON	<ul style="list-style-type: none"> <li>• An active slave station is not set for the parameter.(The slave station is a reserved station.)</li> <li>• The station number of a slave station is duplicated with that of the master station in parameter settings.</li> </ul>	Correct the parameters.
		The parameters in the flash ROM have been corrupted.	Refer to Section 9.5(1).
		<ul style="list-style-type: none"> <li>• An unexpected error other than those specified above occurs.</li> </ul>	Please consult your local Mitsubishi representative, explaining a detailed description of the problem.

\*1 Depending on the number of master stations within the same network and the transmission speed setting, the TOKEN LED seems to be unlit even in execution of token passing. (Refer to Section 5.3)



(2) For the QJ71PB92V (QJ71PB92D-compatible function)

QJ71PB92V  
(92D-compatible)

LED	Status	Cause	Corrective Action
RUN	Goes OFF	The watchdog timer monitoring time is exceeded.	Please consult your local Mitsubishi representative, explaining a detailed description of the problem.
SD/RD	Flashes at a high rate	There is a slave station with which the initial communication cannot be performed. (The parameter does not match the actual slave station).	Please consult your local Mitsubishi representative, explaining a detailed description of the problem.
TOKEN	Goes OFF	The token is not cycled. *1	<ul style="list-style-type: none"> <li>• Make sure that the PROFIBUS-DP cable is connected.</li> <li>• Check the terminating resistance for correct function.</li> <li>• Make sure that the station addresses are not overlapped with each other.</li> <li>• Check if the station number does not exceed the HSA.</li> </ul>
PRM SET	Flashes	The parameter is not set.	Set the parameters using the GX Configurator-DP.
		The parameters in the flash ROM have been corrupted.	Refer to Section 9.5(2).
		Parameters of the QJ71PB92V were written with the QJ71PB92D-compatible function enabled.	<ul style="list-style-type: none"> <li>• Change the module selected in the GX Configurator-DP project to QJ71PB92D, and write the parameters.</li> <li>• Check Switch 2 of the intelligent function module switches. (Refer to Section 5.1.6)</li> </ul>
		Parameters of the QJ71PB92D were written with the QJ71PB92D-compatible function disabled.	<ul style="list-style-type: none"> <li>• Change the module selected in the GX Configurator-DP project to QJ71PB92V, and write the parameters.</li> <li>• Check Switch 2 of the intelligent function module switches. (Refer to Section 5.1.6)</li> </ul>
RSP ERR	Goes ON	A communication trouble occurs.	Read the trouble information from the communication trouble area (Un\G2040 to Un\G2079) of the buffer memory.
FAULT	Goes ON	<ul style="list-style-type: none"> <li>• An active slave station is not set for the parameter. (The slave station is a reserved station.)</li> <li>• The station number of a slave station is duplicated with that of the master station in parameter settings.</li> </ul>	Correct the parameters.
		The parameters in the flash ROM have been corrupted.	Refer to Section 9.5(2).
		An unexpected error other than those specified above occurs.	Please consult your local Mitsubishi representative, explaining a detailed description of the problem.

\*1 Depending on the number of master stations within the same network and the transmission speed setting, the TOKEN LED seems to be unlit even in execution of token passing. (Refer to Section 5.3)

9.2 When Parameters cannot be Written from GX Configurator-DP

The following are troubleshooting methods for the case where parameters are unable to be written from GX Configurator-DP.

(1) For the QJ71PB92D

QJ71PB92D

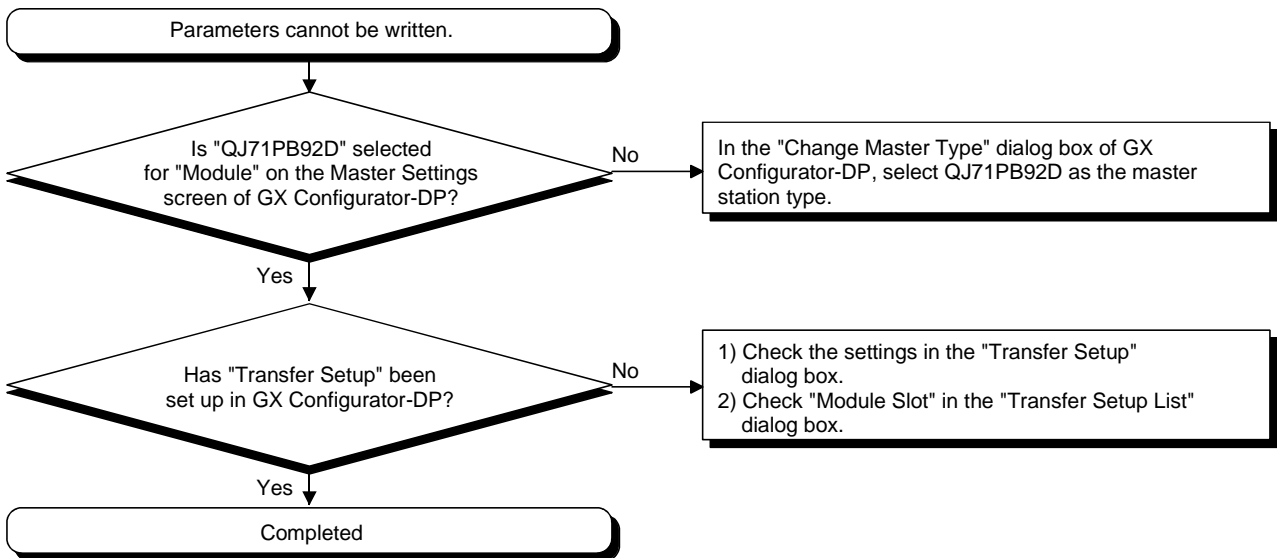

(2) For the QJ71PB92V (QJ71PB92D-compatible function)

QJ71PB92V  
(92D-compatible)

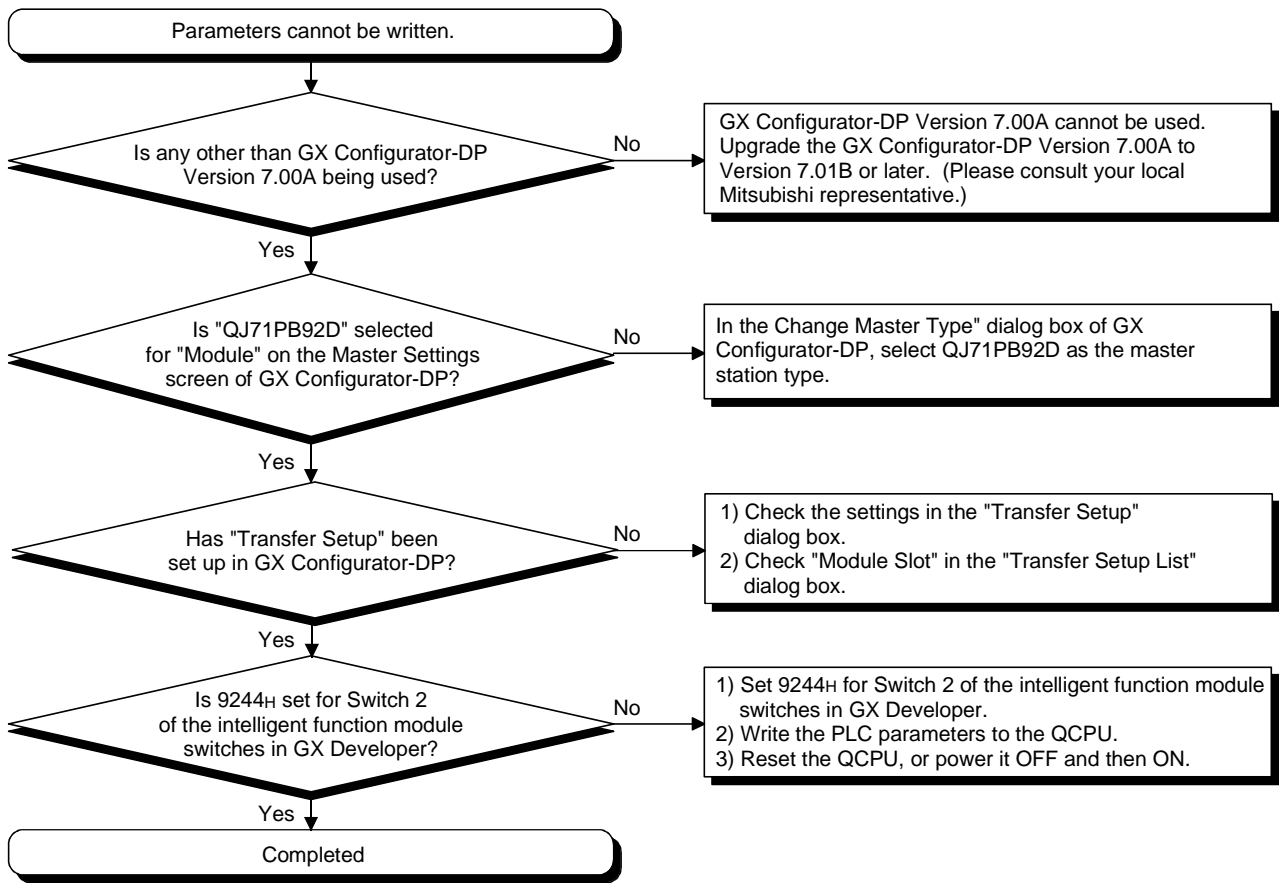

9.3 When Communication with Slave Stations is Not Possible

The following shows the troubleshooting procedures when communications between the QJ71PB92D and slave stations are not possible.

(1) For the QJ71PB92D

QJ71PB92D

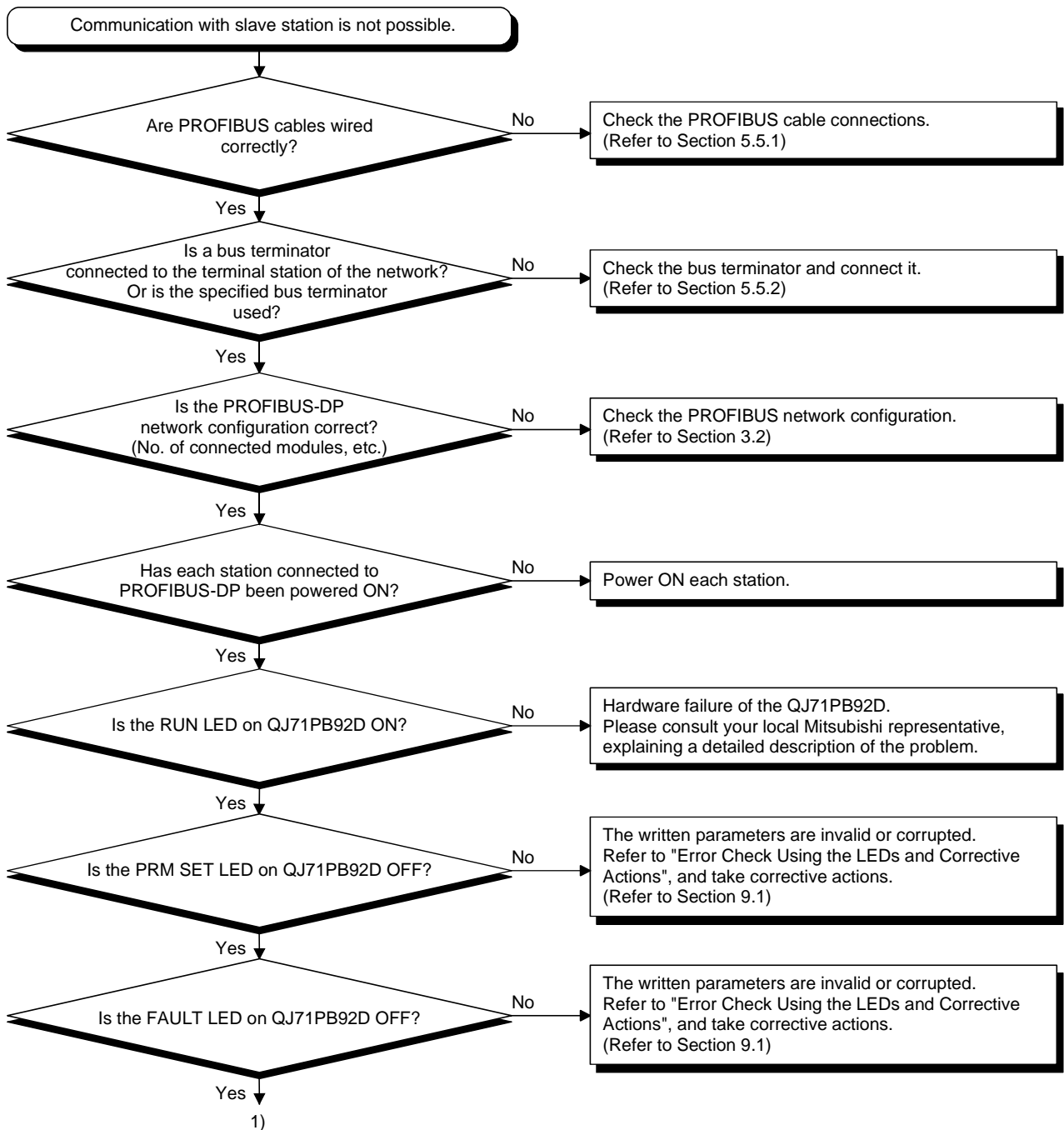

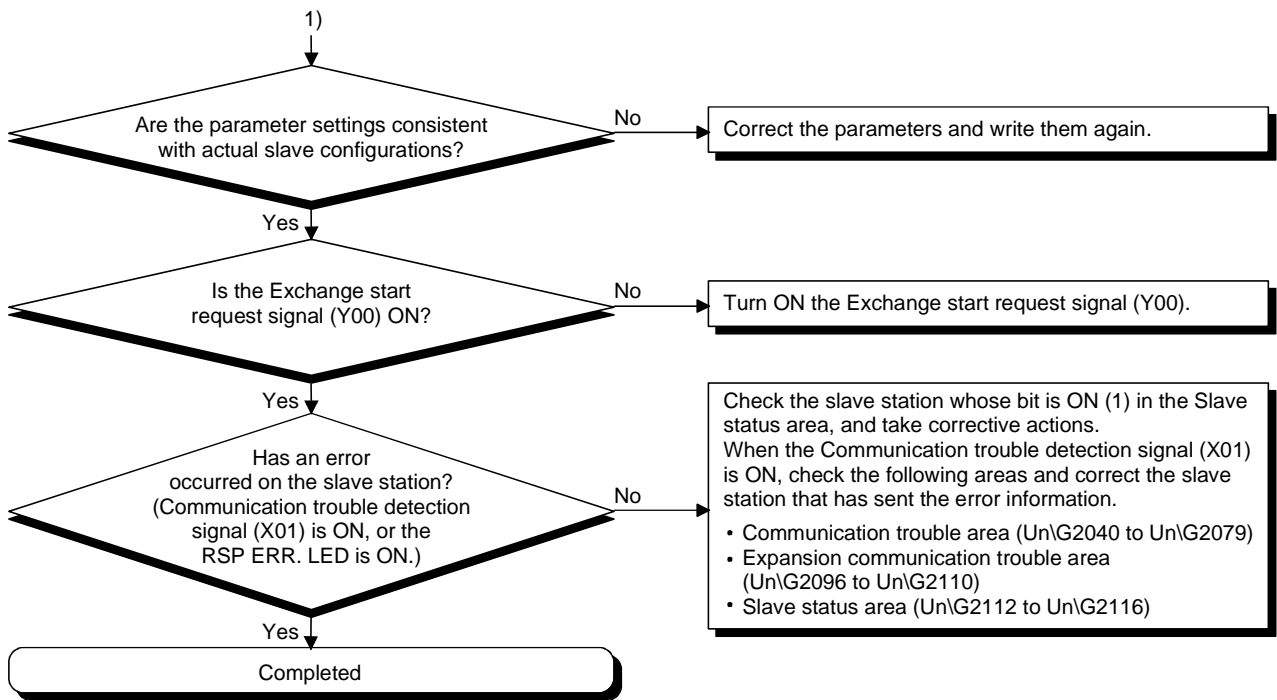

(2) For the QJ71PB92V (QJ71PB92D-compatible function)

QJ71PB92V  
(92D-compatible)

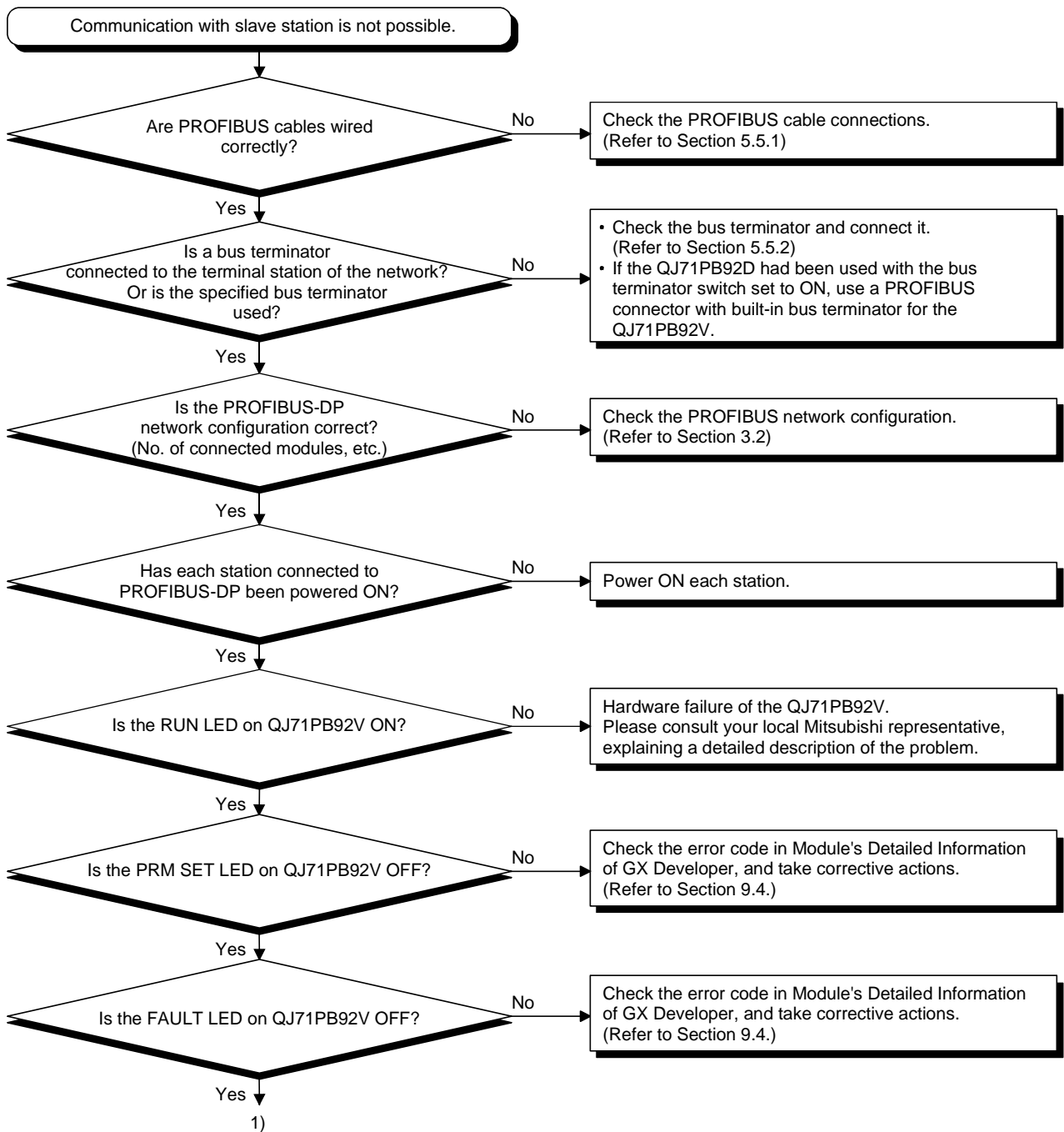

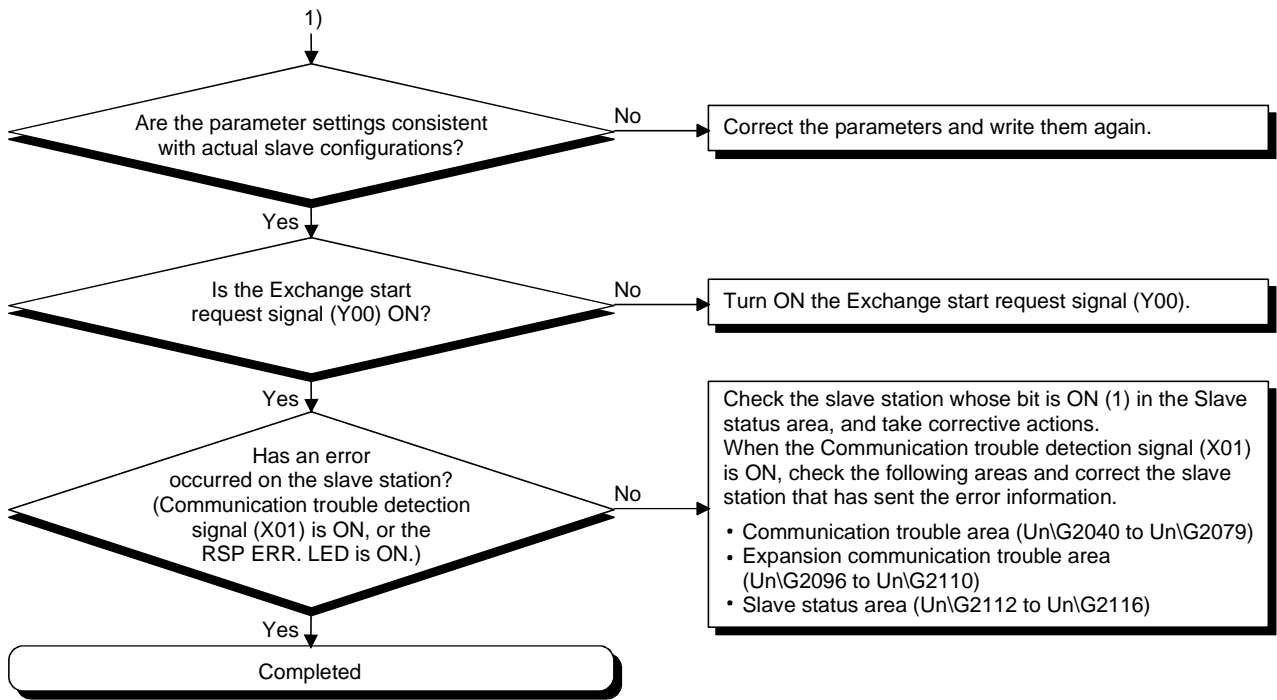

9.4 Error Code

This section explains the error codes that are output on the QJ71PB92D.  
The areas for storing error codes are shown here.

QJ71PB92D

(1) For the QJ71PB92D

Error codes can be checked in the Communication trouble area (Un\G2040 to Un\G2079).

The structure of the Communication trouble area (Un\G2040 to Un\G2079) is shown below.

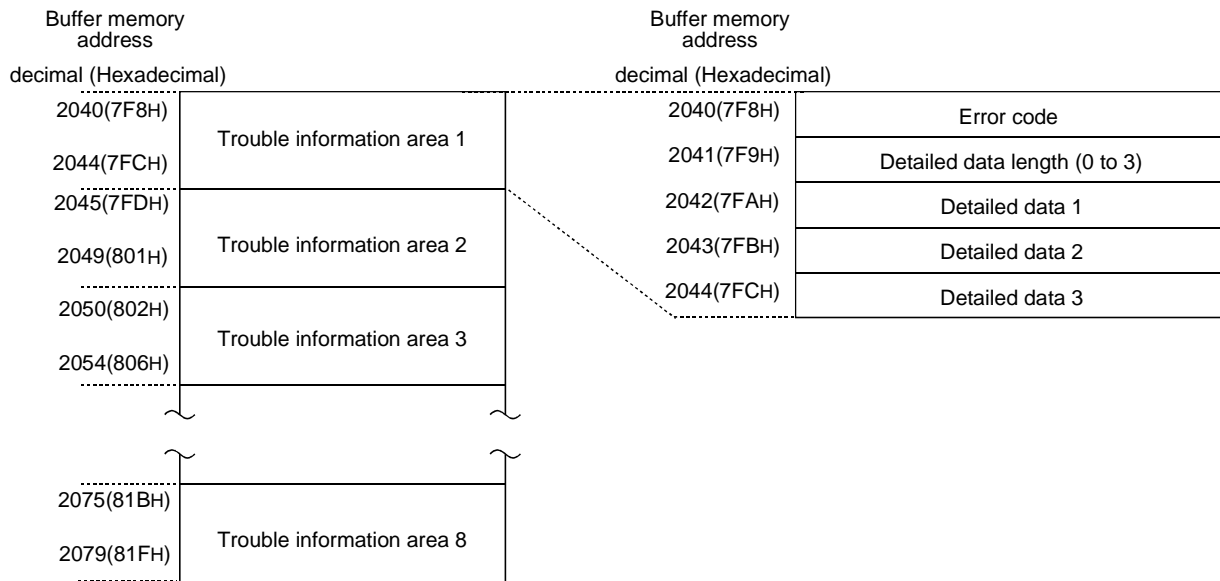

**Remark**

For error codes and detailed data, refer to Section 9.4.1.



QJ71PB92V  
(92D-compatible)

- (2) For the QJ71PB92V (QJ71PB92D-compatible function)
  - More detailed error codes than those of the QJ71PB92D are provided.
  - The error codes can be checked in either of the following.
    - (a) Communication trouble area (Un\G2040 to Un\G2079)
      - The structure of the Communication trouble area (Un\G2040 to Un\G2079) is the same as that of the QJ71PB92D. (Refer to (1) in this section.)
    - (b) Module's Detailed Information of GX Developer
      - The Module's Detailed Information can be displayed by selecting [Diagnostics] → [System monitor] → Module's Detailed Information button.

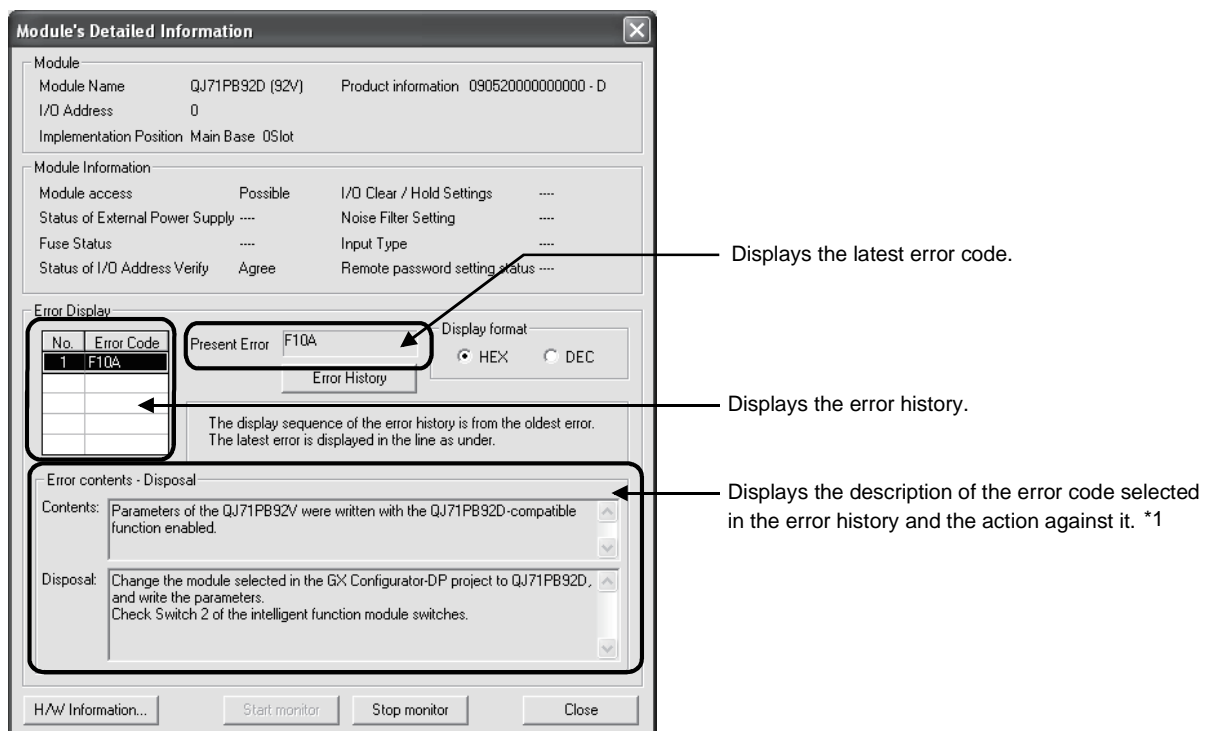

\*1 Display of the contents and disposal is available on GX Developer Version 8.48A or later.

## 9.4.1 Error codes for the QJ71PB92D

The following table lists the error codes for the QJ71PB92D.

Error Code	LED Status	Error Description	Action
0200H	RSP ERR. LED ON	Trouble information was generated on a slave station. When an error occurs, detailed data about the error are stored. (Refer to (1) in this section.)	Check Trouble information area (Un\G2040 to Un\G2079) for trouble information generated in a slave station and take corrective actions. (Refer to (1) in this section.)
1211H	FAULT LED ON <sup>*1</sup>	Station number of a slave station is duplicated with that of the master station in the parameter settings. When an error occurs, the following detailed data are stored. Detailed data length : 1 Detailed data 1 : 03H If the Exchange start request signal (Y00) is turned ON while this error is pending, error code 3000H is generated and the operation is stopped.	Check the station numbers of the master station and slave stations, and set correct parameters without duplication.
1300H	FAULT LED ON <sup>*1</sup>	No slave stations are set to perform I/O data exchange in the parameter settings. (The slave station is a reserved station.) When an error occurs, the following detailed data are stored. Detailed data length : 1 Detailed data 1 : Number of slaves set in the parameter. If the Exchange start request signal (Y00) is turned ON while this error is pending, error code 3000H is generated and the operation is stopped.	Set the slave parameters again so that one or more slave stations will perform I/O data exchange. (Check the "Slave is active" slave parameter.)
1302H	-	The parameter area space is insufficient. When an error occurs, the following detailed data are stored. Detailed data length : 1 Detailed data 1 : Ignored	Reduce the number of connected stations or change the slave station type.
3000H	FAULT LED ON	1) When the above errors 1211H or 1300H have occurred before this error: Refer to errors 1211H, 1300H above. 2) Otherwise An unexpected error has occurred.	For 1) Refer to the above 1211H, 1300H errors. For 2) Consult your local Mitsubishi representative, explaining a detailed description of the problem.

\*1 The FAULT LED lights up when the Exchange start request signal (Y00) is turned ON while an error is pending.

**REMARK**

For error codes, detailed data length, and storage location of detailed data, refer to Section 9.4.

(1) In the case of error code 0200H

Information on errors occurred on slave stations is stored in the Communication trouble area (Un\G2040 to Un\G2079).

Error information is stored as shown below.

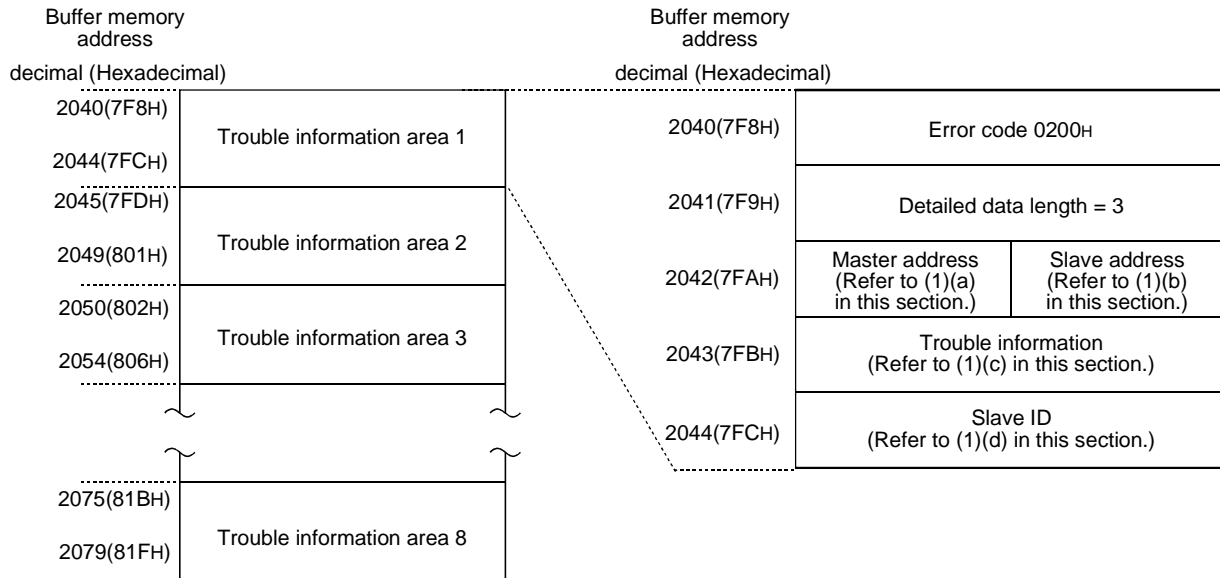

(a) Master address

The station address of the master station that controls the slave station in which this trouble information occurred is stored.

However, FFH is stored when the trouble information shows the exchange with the slave is failed.

(b) Slave address

The station number of the slave station in which this trouble information occurred is stored.

(c) Trouble information

Trouble information is stored as a string of 16 bits.

A bit corresponding to the failure occurred turns ON, indicating the following error details.

Even if any of the following errors has occurred, I/O data exchange between the master and slave stations is continued.

Bit	Description	Action	Detected in
b0	Parameter transmission request from a slave station.	(1) When I/O data exchange is started Normally operating (This occurs every time I/O data exchange is started.) (2) While I/O data are exchanged Check the slave station status and communication line.	slave station
b1	Trouble information read request.	Check the slave station status.	slave station
b2	0 (Fixed)	—	—

(To the next page)

Bit	Description	Action	Detected in
b3	The slave station is monitored by the watchdog timer.	Normally operating	slave station
b4	The slave station entered FREEZE mode.	Normally operating	slave station
b5	The slave station entered SYNC mode.	Normally operating	slave station
b6	0 (Reserved)	—	—
b7	Excluded from I/O data exchange according to the parameter settings.	(1) When I/O data exchange is stopped Normally operating (This occurs every time I/O data exchange is stopped.) (2) While I/O data are exchanged Check if any parameter has been changed from the class 2 master station on the network.	master station
b8	Unable to exchange I/O data with slave station.	Check the slave station status and communication line. Check the parameters.	master station
b9	The slave station is not ready to exchange I/O data.	(1) When I/O data exchange is started Normally operating (This occurs every time I/O data exchange is started.) (2) While I/O data are exchanged Check the slave station status and communication line.	slave station
b10	The parameter (No. of I/O bytes) received from the master station does not match that of the slave station.	Check the slave station parameters.	slave station
b11	There is some expansion trouble information.	Check the slave station status.	master station
b12	The function requested by the master station is not supported.	Check if the slave station supports the global control function or not. Verify the slave station specifications.	slave station
b13	Illegal response from slave station.	Check the slave station or network status.	master station
b14	Illegal parameter(s) sent from the master station.	Check the parameters.	slave station
b15	Controlled by another master station.	Check if more than one master station are communicating with the same slave station. Check the parameters.	master station

**(d) Slave ID**

Individual slave inherent ID No. from the PNO is stored. However, FF<sub>H</sub> is stored for trouble information that shows that the exchange with the slave failed.

**REMARK**

The expansion communication trouble information is stored in Expansion communication trouble area (Un\G2096 to Un\G2110) for only the latest trouble information of the error code = 0200<sub>H</sub> trouble information.

QJ71PB92V  
(92D-compatible)

## 9.4.2 Error codes for the QJ71PB92V (QJ71PB92D-compatible function)

The following table lists the error codes for the QJ71PB92V (QJ71PB92D-compatible function).

## (1) Error codes, 0200H to 3000H

Error Code	LED Status	Error Description	Action
0200H	RSP ERR. LED ON	Trouble information was generated on a slave station. When an error occurs, detailed data about the error are stored. (Refer to 9.4.1(1).)	Check Trouble information area (Un\G2040 to Un\G2079) for trouble information generated in a slave station and take corrective actions. (Refer to 9.4.1(1).)
1211H	FAULT LED ON	Station number of a slave station is duplicated with that of the master station in the parameter settings. When an error occurs, the following detailed data are stored. Detailed data length : 1 Detailed data 1 : 03H	Check the station numbers of the master station and slave stations, and set correct parameters without duplication.
1300H	FAULT LED ON <sup>*1</sup>	No slave stations are set to perform I/O data exchange in the parameter settings. (The slave station is a reserved station.) When an error occurs, the following detailed data are stored. Detailed data length : 1 Detailed data 1 : Number of slaves set in the parameter. If the Exchange start request signal (Y00) is turned ON while this error is pending, error code 3000H is generated and the operation is stopped.	Set the slave parameters again so that one or more slave stations will perform I/O data exchange. Check the "Slave is active" slave parameter.
3000H	FAULT LED ON	1) When the above errors 1211H or 1300H have occurred before this error: Refer to errors 1211H, 1300H above. 2) Otherwise An unexpected error has occurred.	For 1) Refer to the above 1211H, 1300H errors. For 2) Consult your local Mitsubishi representative, explaining a detailed description of the problem.

\*1 The FAULT LED lights up when the Exchange start request signal (Y00) is turned ON while an error is pending.

**REMARK**

For error codes, detailed data length, and storage location of detailed data, refer to Section 9.4.

## (2) Error codes, F100H to F1FFH

In the QJ71PB92V (QJ71PB92D-compatible function), more detailed error codes than those of the QJ71PB92D can be checked.

Error Code	LED Status	Error Description	Action
F100H	FAULT LED ON	Station number of a slave station is duplicated with that of the master station in the parameter settings.	Check the station numbers of the master station and slave stations, and set correct parameters without duplication.
F101H	FAULT LED ON	No slave stations are set to perform I/O data exchange in the parameter settings. (The slave station is a reserved station.)	Set the slave parameters again so that one or more slave stations will perform I/O data exchange. (Refer to Section 9.4.1(2).) (Check the "Slave is active" slave parameter.)
F102H	FAULT LED ON	Hardware failure	Replace the QJ71PB92V.
F103H			If the same error occurs again, please consult your local Mitsubishi representative, explaining a detailed description of the problem.
F104H			
F105H			
F106H	PRM SET LED flashing	Parameters have not been written to the flash ROM.	Write the parameters.
F107H	FAULT LED ON	The parameters or operation mode read from the flash ROM are corrupted.	Initialize the flash ROM, and then write the parameters and operation mode. If the same error occurs again, replace the QJ71PB92V.
F108H	FAULT LED ON	Unable to access the flash ROM. Or failed to initialize the flash ROM.	Initialize the flash ROM. If the same error occurs again, replace the QJ71PB92V.
F109H	PRM SET LED flashing	Parameters of the QJ71PB92D were written with the QJ71PB92D-compatible function disabled.	<ul style="list-style-type: none"> <li>Change the module selected in the GX Configurator-DP project to QJ71PB92V, and write the parameters.</li> <li>Check Switch 2 of the intelligent function module switches. (Refer to Section 5.1.6.)</li> </ul>
F10AH	PRM SET LED flashing	Parameters of the QJ71PB92V were written with the QJ71PB92D-compatible function enabled.	<ul style="list-style-type: none"> <li>Change the module selected in the GX Configurator-DP project to QJ71PB92D, and write the parameters.</li> <li>Check Switch 2 of the intelligent function module switches. (Refer to Section 5.1.6.)</li> </ul>
F10BH	FAULT LED ON	Unable to read the operation mode registered to the flash ROM.	Initialize the flash ROM. If the same error occurs again, replace the QJ71PB92V.
F10CH	PRM SET LED flashing	In the parameter settings, there is a slave station whose I/O data size is set to 0 byte.	Check the slave parameters, and make the setting again to ensure that the I/O data size of each slave station is 1byte or more.
F10DH	PRM SET LED flashing	Parameter error	Initialize the flash ROM. If the same error occurs again, please consult your local Mitsubishi representative, explaining a detailed description of the problem.
F10EH	FAULT LED ON	Hardware failure	Please consult your local Mitsubishi representative, explaining a detailed description of the problem.
F10FH			

(To the next page)

Error Code	LED Status	Error Description	Action
F110H	—	Although Dedicated instruction valid signal (Y0C) is ON, the BBLKRD instruction is not executed.	Modify the sequence program so that the BBLKRD instruction is executed when Dedicated instruction valid signal (Y0C) is ON.
F111H	—	Although Dedicated instruction valid signal (Y0C) is ON, the BBLKWR instruction is not executed.	Modify the sequence program so that the BBLKWR instruction is executed when Dedicated instruction valid signal (Y0C) is ON.
F112H	—	Although Dedicated instruction valid signal (Y0C) is ON, the BBLKRD and BBLKWR instructions are not executed.	Modify the sequence program so that the BBLKRD and BBLKWR instructions are executed when Dedicated instruction valid signal (Y0C) is ON.
F113H	—	Dedicated instruction valid signal (Y0C) was turned ON during execution of the data separation prevention function in automatic refresh.	The data separation prevention function in automatic refresh and dedicated instructions are not concurrently executable. In the master parameter setting of GX Configurator-DP, disable the separation prevention function. (Refer to Section 5.1.2.)
F120H	RSP ERR. LED ON	Trouble information was generated on a slave station. When an error occurs, detailed data about the error are stored. (Refer to 9.4.1(1). )	Check Trouble information area (Un\G2040 to Un\G2079) for trouble information generated in a slave station and take corrective actions. (Refer to 9.4.1(1).) In the communication trouble area (Un\G2040 to Un\G2079), error code 0200H is stored.
F121H	RSP ERR. LED ON	There is a master station or slave station that has a duplicated station number on the same line.	Check the station number of the master station and slave stations, and set correct parameters without duplication.
F122H	RSP ERR. LED ON	An error has been detected on the line. Or, some master parameter is not appropriate.	Check the wiring status of the bus terminator(s) and PROFIBUS cable(s). If the terminating resistor and PROFIBUS cable wiring status is correct, increase the set value of the master parameter, "Min. slave interval".
F123H			
F124H			
F125H	RSP ERR. LED ON	The master station is in the clear request transmission status.	Since "Error action flag" is check-marked in the master parameter settings, the clear request has been sent to all slave stations. To disable transmission of the clear request, uncheck "Error action flag".
F1FEH	FAULT LED ON	Hardware failure	Please consult your local Mitsubishi representative, explaining a detailed description of the problem.
F1FFH			

<b>REMARK</b>
---------------

For error codes, detailed data length, and storage location of detailed data, refer to Section 9.4.

## 9.5 Initialization of Flash ROM When Parameters are Corrupted

When the PRM SET LED is flickering and the FAULT LED has turned on, the parameters in the flash ROM may have been corrupted.

If this occurs, rewrite the parameters or initialize the flash ROM according to the procedures given in this section.

QJ71PB92D

## (1) For the QJ71PB92D

- (a) Set the CPU module to the STOP status.
- (b) Read the file (PLC parameter) from the CPU module using GX Developer.
- (c) In the I/O assignment settings of the PLC parameter dialog box, make the switch settings of the QJ71PB92D as shown below.

Set the input format to "HEX".

Enter "FF01" into Switch 1 and 5. Leave the fields for Switches 2 to 4 blank (no setting).

After entering values into Switch 1 and 5, click the End button.

Slot	Type	Model name	Switch 1	Switch 2	Switch 3	Switch 4	Switch 5
0	PLC	PLC					
1	3 <sup>α</sup> -9 <sup>β</sup>	Intell.	FF01				FF01
2	1 <sup>α</sup> -1 <sup>β</sup>						
3	2 <sup>α</sup> -2 <sup>β</sup>						
4	3 <sup>α</sup> -3 <sup>β</sup>						
5	4 <sup>α</sup> -4 <sup>β</sup>						
6	5 <sup>α</sup> -5 <sup>β</sup>						
7	6 <sup>α</sup> -6 <sup>β</sup>						
8	7 <sup>α</sup> -7 <sup>β</sup>						
9	8 <sup>α</sup> -8 <sup>β</sup>						
10	9 <sup>α</sup> -9 <sup>β</sup>						
11	10 <sup>α</sup> -10 <sup>β</sup>						
12	11 <sup>α</sup> -11 <sup>β</sup>						
13	12 <sup>α</sup> -12 <sup>β</sup>						
14	13 <sup>α</sup> -13 <sup>β</sup>						
15	14 <sup>α</sup> -14 <sup>β</sup>						

- (d) Write the new PLC parameters to the CPU module, and reapply the power or reset the CPU module.
- (e) When the processing in Step (d) is performed, the QJ71PB92D starts up in the parameter setting mode (MODE 1). Perform the following steps 1) to 11) by the Device test of GX Developer to initialize the flash ROM.
  - 1) Write "9H" to the buffer memory address 2255 (8CF<sub>H</sub>) of the QJ71PB92D.
  - 2) Turn ON the operation mode change request signal (Y11).
  - 3) When the operation mode change completion signal (X11) has turned ON, turn OFF the operation mode change request signal (Y11).
  - 4) Write "FH" to the buffer memory address 2255 (8CF<sub>H</sub>) of the QJ71PB92D.
  - 5) Turn ON the operation mode change request signal (Y11).
  - 6) When the operation mode change completion signal (X11) has turned ON, turn OFF the operation mode change request signal (Y11).
  - 7) Write "AH" to the buffer memory address 2255 (8CF<sub>H</sub>) of the QJ71PB92D.
  - 8) Turn ON the operation mode change request signal (Y11).
  - 9) When the operation mode change completion signal (X11) has turned ON, turn OFF the operation mode change request signal (Y11).



- 10) The TEST LED turns ON and the initialization of the flash ROM starts.
- 11) When the TEST LED turns OFF, the initialization of the flash ROM is completed.
- (f) Read the file (PLC parameter) from the CPU module using GX Developer.
- (g) In the I/O assignment settings of the PLC parameter dialog box, delete the switch settings of the QJ71PB92D.

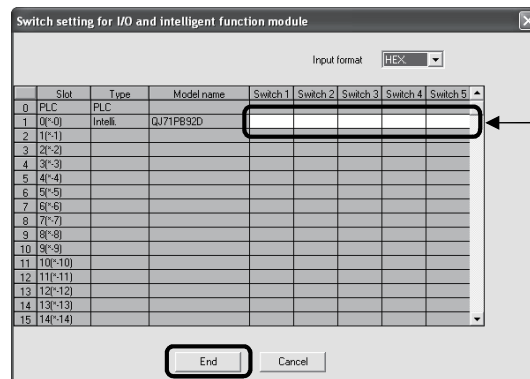

Delete settings of Switch 1 and 5.

After deleting settings of Switch 1 and 5, click the End button.

- (h) Write the PLC parameters, whose switch settings have been deleted, to the CPU module, and reapply the power or reset the CPU module.
- (i) When the PRM SET LED turns ON, the initialization of the flash ROM is normally completed. (The QJ71PB92D has returned to the initial status.) If the PRM SET LED does not turn ON, please contact your local Mitsubishi representative.
- (j) When the PRM SET LED has turned ON, write the parameters of the QJ71PB92D using GX Configurator-DP.

QJ71PB92V  
(92D-compatible)

## (2) For the QJ71PB92V (QJ71PB92D-compatible function)

Set the CPU module to the STOP status.

Perform the following steps by using the Device test on the GX Developer

- 1) Write "9H" to the buffer memory address 2255 (8CFH) of the QJ71PB92V (QJ71PB92D-compatible function).
- 2) Turn ON the operation mode change request signal (Y11).
- 3) When the operation mode change completion signal (X11) has turned ON, turn OFF the operation mode change request signal (Y11).
- 4) Write "FH" to the buffer memory address 2255 (8CFH) of the QJ71PB92V (QJ71PB92D-compatible function).
- 5) Turn ON the operation mode change request signal (Y11).
- 6) When the operation mode change completion signal (X11) has turned ON, turn OFF the operation mode change request signal (Y11).
- 7) Write "AH" to the buffer memory address 2255 (8CFH) of the QJ71PB92V (QJ71PB92D-compatible function).
- 8) Turn ON the operation mode change request signal (Y11).
- 9) When the operation mode change completion signal (X11) has turned ON, turn OFF the operation mode change request signal (Y11).
- 10) The TEST LED turns ON and the initialization of the flash ROM starts.
- 11) When the TEST LED turns OFF, the initialization of the flash ROM is completed.
- 12) Reapply power to or reset the CPU module
- 13) When the PRM SET LED turns ON, the initialization of the flash ROM is normally completed. (The QJ71PB92V (QJ71PB92D-compatible function) has returned to the initial status.)  
If the PRM SET LED does not turn ON, please contact your local Mitsubishi representative.
- 14) When the PRM SET LED has turned ON, write the parameters of the QJ71PB92D using GX Configurator-DP.

## APPENDICES

## Appendix 1 Replacement with the QJ71PB92V (QJ71PB92D-compatible function)

The QJ71PB92V has a function for replacing the QJ71PB92D with the QJ71PB92V. (QJ71PB92D-compatible function)

When the QJ71PB92D has failed, replace it with the QJ71PB92V using the QJ71PB92D-compatible function.

Since the existing network configuration and sequence programs for the QJ71PB92D can be utilized, a faulty QJ71PB92D can be smoothly replaced with the QJ71PB92V.

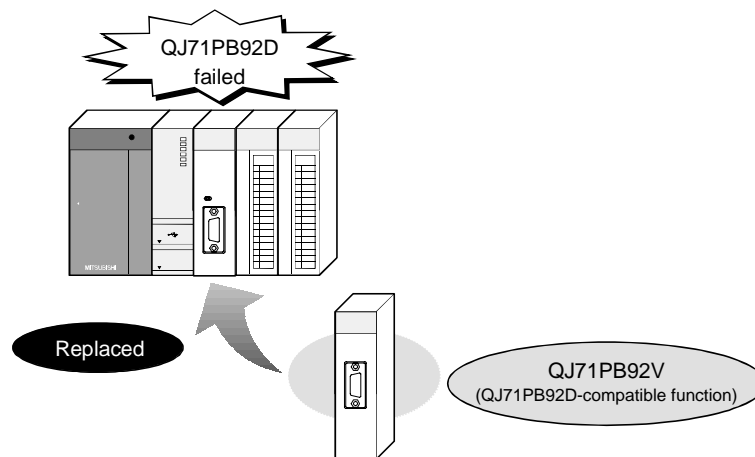

Appendix 1.1 Precautions for replacing the QJ71PB92D with the QJ71PB92V

When replacing the QJ71PB92D with the QJ71PB92V, pay attention to the following precautions before replacement.

(1) Before the replacement

Item		Description	Reference
The QJ71PB92V that supports the QJ71PB92D-compatible function		Select the QJ71PB92V whose first 5 digits of serial No. is 09052 or later.	—
Applicable GX Configurator-DP		<ul style="list-style-type: none"> <li>• GX Configurator-DP Version 4: Applicable</li> <li>• GX Configurator-DP Version 5: Applicable</li> <li>• GX Configurator-DP Version 6: Applicable</li> <li>• GX Configurator-DP Version 7: Select Version 7.01B or later.</li> </ul> <p>For GX Configurator-DP Version 7.00A, upgrade it to Version 7.01B or later. For version upgrades, please consult your local Mitsubishi representative.</p>	Section 2.1(4)
PROFIBUS interface connector		The position of the PROFIBUS interface connector on the QJ71PB92V is moved up by 17mm (0.67 inch), compared with the QJ71PB92D. If the PROFIBUS cable is not long enough, extend the cable length by using an extension connector *1.	Section 5.5.1
Bus terminator		The QJ71PB92V does not have a built-in bus terminator. When the bus terminator setting of the QJ71PB92D has been set to ON, use a connector with a built-in bus terminator *1.	Section 5.5.2
Parameter setting	GX Developer	Set Switch 2 of the intelligent function module switches to "9244H". Setting Switch 2 to "9244H" enables the QJ71PB92D-compatible function. Make this setting before writing project data from GX Configurator-DP.	Section 5.1(2), 5.1.6
	GX Configurator-DP	GX Configurator-DP projects used for the QJ71PB92D can be utilized without change. When creating a new project in GX Configurator-DP, select "QJ71PB92D" as the module type.	Section 5.1(2)
Transmission delay time		<p>The transmission delay time of the QJ71PB92V (QJ71PB92D-compatible function) may be different from that of the QJ71PB92D depending on the system configuration. (The timing of updating the I/O data varies.)</p> <p>After replacement with the QJ71PB92V, please fully examine that there is no problem on the control of the target system.</p>	Chapter 6

\*1 For details on PROFIBUS cables and connectors, access the following website.

• PROFIBUS International: <http://www.profibus.com/>

## (2) After the replacement

Item	Description	Reference
Value stored in Self-diagnosis status code area (UnG2258)	A different value is stored.	Section 5.4 (2)
Error codes	More detailed error codes than those of the QJ71PB92D can be checked.	Section 9.4 (2)
Flash ROM initialization procedure taken when parameters are corrupted.	The intelligent function module switch setting is not required for the initialization.	Section 9.5 (2)

## Appendix 2 Differences between QJ71PB92D and A1SJ71PB92D/AJ71PB92D

The differences between QJ71PB92D of MELSEC-Q series and A1SJ71PB92D/AJ71PB92D of MELSEC-A series are shown below.

The A1SJ71PB92D and AJ71PB92D to be used here are of software version F and subsequent and software version B and subsequent, respectively.

For the modules of the software versions earlier than those stated above, refer to the PROFIBUS-DP Interface Module Type AJ71PB92D/A1SJ71PB92D User's Manual (IB-66773) to confirm the difference between these software versions.

## (1) Functions and specifications

Item \ Model name	QJ71PB92D	A1SJ71PB92D/AJ71PB92D
Separation prevention function	<ul style="list-style-type: none"> <li>• Auto Refresh</li> <li>• Dedicated instruction (When using the FROM/TO instructions, data separation cannot be prevented.)</li> </ul>	FROM/TO instruction
Auto refresh setting	Present	Absent
Word data swap function	Present	Absent
Operation mode setting method	<ul style="list-style-type: none"> <li>• GX Configurator-DP</li> <li>• Sequence program</li> </ul>	<ul style="list-style-type: none"> <li>• Sequence program</li> <li>• Mode set switch</li> </ul>
Parameter writing by configuration software	Connected to RS-232 connector of QCPU (Q mode) or USB connector	<ul style="list-style-type: none"> <li>• Connected to RS-232C interface of A1SJ71PB92D/AJ71PB92D</li> <li>• Connected to RS-422 of CPU module</li> </ul>
	via. MELSECNET/H and Ethernet	via. MELSECNET/10 and Ethernet
Compatible configuration software	GX Configurator-DP	SW05F-PROFIMAP MELSEC PROFIMAP Version1 MELSEC PROFIMAP Version2 MELSEC PROFIMAP Version3 GX Configurator-DP

Appendix 3 Extended Trouble Information of Mitsubishi's Slaves

(1) AJ95TB2-16T

AJ95TB2-16T notifies device-related trouble information to the master. The information consists of seven bytes including the header (one byte) as shown below:

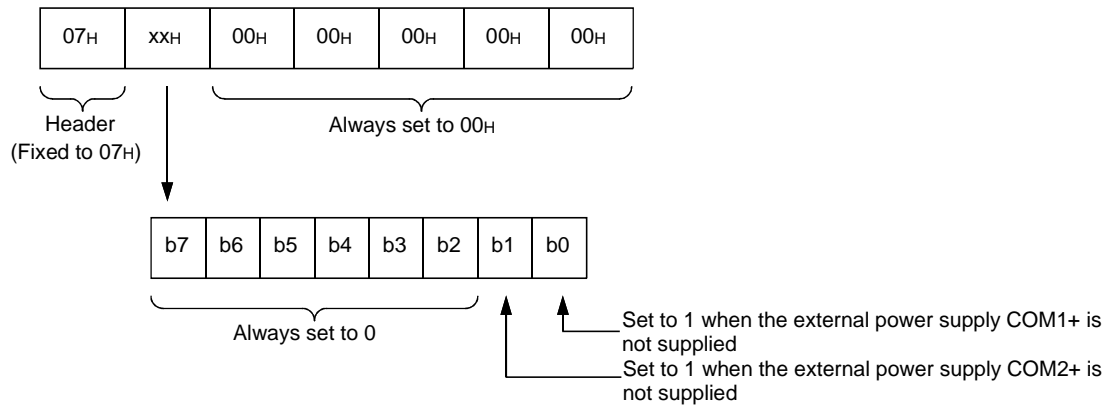

(2) AJ95TB32-16DT

AJ95TB32-16DT notifies device-related trouble information to the master. The information consists of seven bytes including the header (one byte) as shown below:

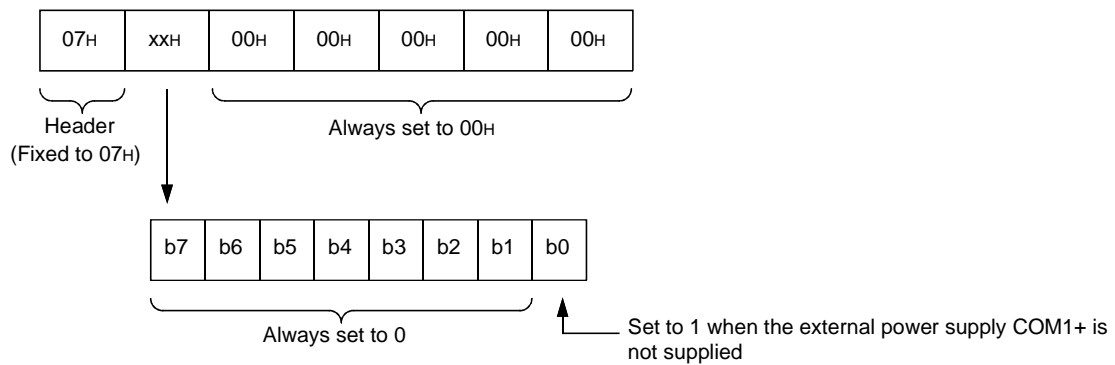

(3) AJ95TB3-16D

AJ95TB3-16D notifies device-related trouble information to the master. The information consists of seven bytes including the header (one byte) as shown below:

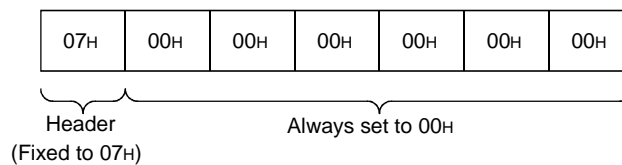

Appendix 4 External Dimensions

(1) For the QJ71PB92D

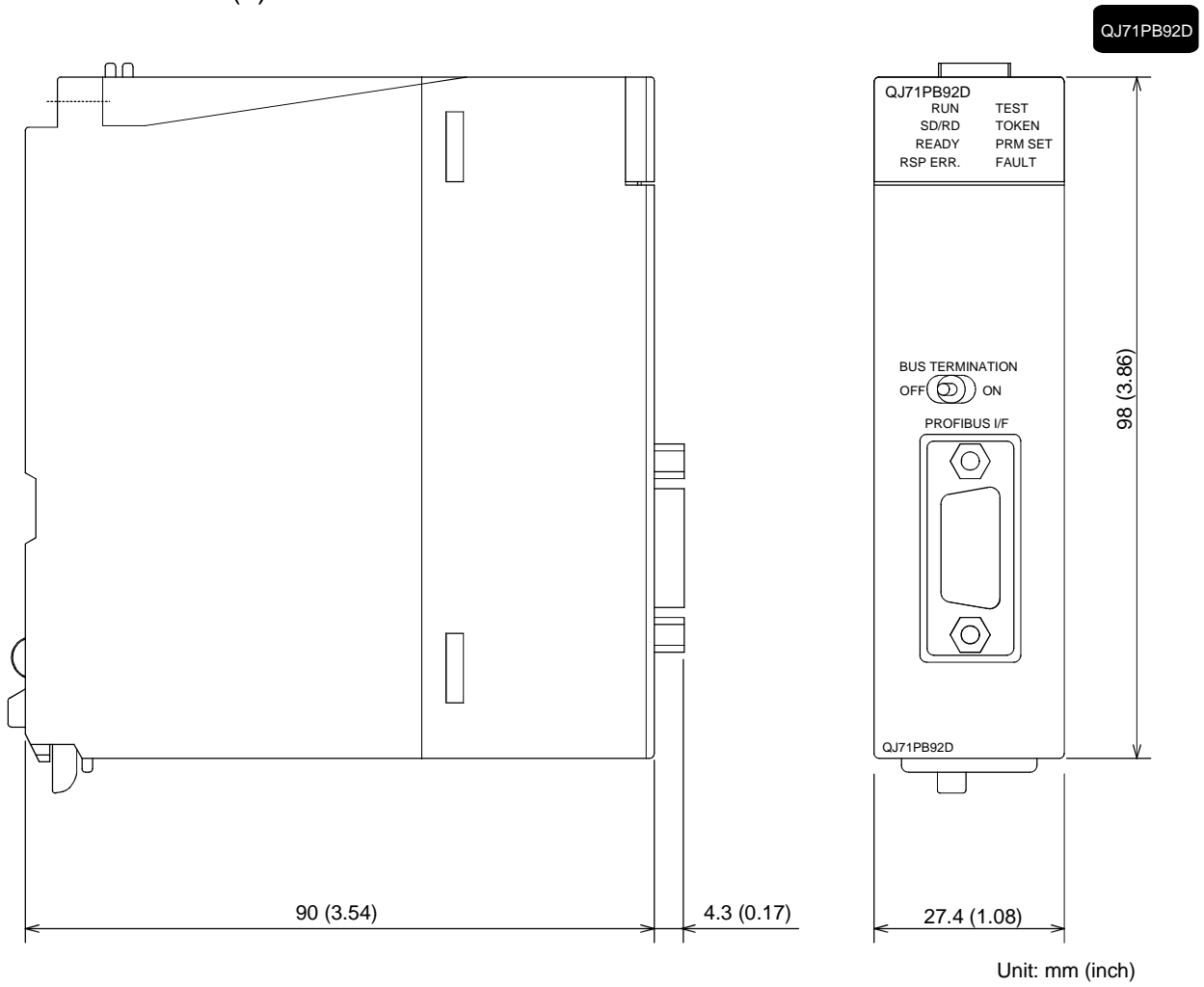



(2) For the QJ71PB92V (QJ71PB92D-compatible function)

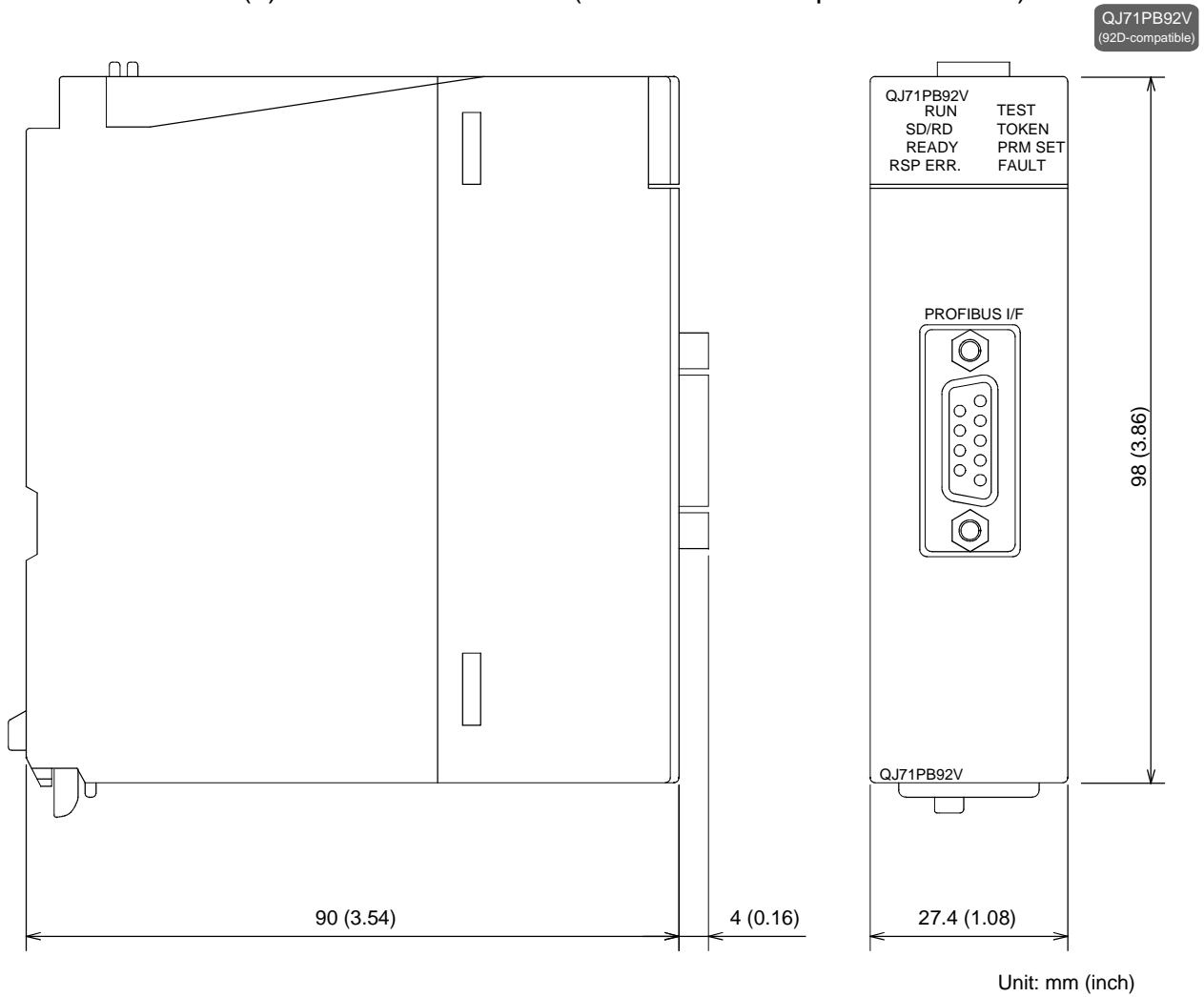



INDEX

[A]

A1SJ71PB92D/ AJ71PB92D ..... App-4

Applicable system .....2- 1

Areas

- Address information area ..... 3-30
- Communication trouble area..... 3-33
- Current operation mode area..... 3-49
- Expansion communication trouble area ... 3-35
- Global control area ..... 3-42
- Input area..... 3-23
- Input/output start address area ..... 3-46
- Local station number display area..... 3-50
- Operation mode change request area..... 3-49
- Operation mode change result area ..... 3-50
- Output area..... 3-27
- Self-diagnosis status code area..... 3-50
- Slave trouble information cancel area ..... 3-41
- Slave status area..... 3-45
- Trouble no information time setting area .. 3-44

Automatic refresh

- Communication using.....7- 4
- Number of ..... 5-21
- Parameters ..... 5-15
- Setting..... 5-16
- Writing..... 5-20

[B]

- Baud rate ..... 3- 1, 5- 7
- BBLKRD .....8- 3
- BBLKWR .....8- 4
- Buffer memory..... 3-22
- Bus cycle time ..... 6- 1, 2
- Bus parameter..... 5-10
- Bus terminator ..... 5-32

[C]

Compatible software packages .....2- 2

Configuration

- Multimaster configuration .....3- 7
- Network configuration.....3- 3
- System configuration.....2- 1
- Configurator software .....2- 2

Connectors

- Pin arrangement of connectors.....5-30
- PROFIBUS interface connector.....5-31
- CPU .....2- 1

[D]

- Dedicated instruction.....8- 1

[E]

- Error code.....9-10
- Expansion communication trouble .....3-35
- Extended service mode (MODE E) .....4-16

[F]

- Functions .....4- 1
- Function version.....2- 5

[G]

- Global control function .....4- 3
- Group.....4- 3
- GSD file ..... A-11
- GX Configurator-DP ..... 2- 2, 5- 5

[I]

- I/O signal .....3-12
- Intelligent function module switch setting .....5-23

[L]

- LED..... 5-27, 9- 2

[M]

- Master parameter.....5- 7
- MODE

  - MODE 0 ..... 3-24, 27, 4-15
  - MODE 1 .....4-13
  - MODE 2 .....5-28
  - MODE E ..... 3-25, 27, 4-16

- Mountable

  - Base unit.....2- 1
  - CPU module .....2- 1

- Multi-master system ..... 3- 4, 3- 7

[N]

- Network configuration .....3- 3
- Normal service mode (MODE 0) .....4-15
- Number of connectable slaves .....3- 9

[O]	
Operation mode .....	4-13
Output status setting for the case of a CPU stop error .....	4-17

[P]	
Parameters .....	5- 6
Automatic refresh .....	5-15
Bus .....	5-10
Master .....	5- 7
Slave .....	5-12
Performance specifications.....	3- 1
Procedures	
Parameter setting procedure .....	5- 6
Procedures before operation .....	5- 1
PROFIBUS cable .....	5-30
PROFIBUS-DP .....	1- 3
PROFIMAP.....	App- 3
Programming.....	7- 1

[Q]	
QJ71PB92D compatible-function .....	A-11, App-1

[R]	
Replacement with the QJ71PB92V .....	App-1

[S]	
Self-diagnosis	
Self-diagnosis mode.....	5-28
Self-diagnosis procedure .....	5-28
Separation .....	4-10
Serial No. ....	2- 5
Slave parameter .....	5-12
Specifications .....	3- 1
Swap.....	4- 7
SYNC.....	4- 4
System configuration.....	2- 1

[T]	
Terminator switch.....	5-32
Transmission delay time .....	6- 5
Trouble information .....	9-13
Troubleshooting.....	9- 1

[U]	
UNSYNC .....	4- 4

[W]	
Wiring .....	5-30

# WARRANTY

Please confirm the following product warranty details before using this product.

## 1. Gratis Warranty Term and Gratis Warranty Range

If any faults or defects (hereinafter "Failure") found to be the responsibility of Mitsubishi occurs during use of the product within the gratis warranty term, the product shall be repaired at no cost via the sales representative or Mitsubishi Service Company.

However, if repairs are required onsite at domestic or overseas location, expenses to send an engineer will be solely at the customer's discretion. Mitsubishi shall not be held responsible for any re-commissioning, maintenance, or testing on-site that involves replacement of the failed module.

### [Gratis Warranty Term]

The gratis warranty term of the product shall be for one year after the date of purchase or delivery to a designated place.

Note that after manufacture and shipment from Mitsubishi, the maximum distribution period shall be six (6) months, and the longest gratis warranty term after manufacturing shall be eighteen (18) months. The gratis warranty term of repair parts shall not exceed the gratis warranty term before repairs.

### [Gratis Warranty Range]

- (1) The range shall be limited to normal use within the usage state, usage methods and usage environment, etc., which follow the conditions and precautions, etc., given in the instruction manual, user's manual and caution labels on the product.
- (2) Even within the gratis warranty term, repairs shall be charged for in the following cases.
  1. Failure occurring from inappropriate storage or handling, carelessness or negligence by the user. Failure caused by the user's hardware or software design.
  2. Failure caused by unapproved modifications, etc., to the product by the user.
  3. When the Mitsubishi product is assembled into a user's device, Failure that could have been avoided if functions or structures, judged as necessary in the legal safety measures the user's device is subject to or as necessary by industry standards, had been provided.
  4. Failure that could have been avoided if consumable parts (battery, backlight, fuse, etc.) designated in the instruction manual had been correctly serviced or replaced.
  5. Failure caused by external irresistible forces such as fires or abnormal voltages, and Failure caused by force majeure such as earthquakes, lightning, wind and water damage.
  6. Failure caused by reasons unpredictable by scientific technology standards at time of shipment from Mitsubishi.
  7. Any other failure found not to be the responsibility of Mitsubishi or that admitted not to be so by the user.

## 2. Onerous repair term after discontinuation of production

- (1) Mitsubishi shall accept onerous product repairs for seven (7) years after production of the product is discontinued. Discontinuation of production shall be notified with Mitsubishi Technical Bulletins, etc.
- (2) Product supply (including repair parts) is not available after production is discontinued.

## 3. Overseas service

Overseas, repairs shall be accepted by Mitsubishi's local overseas FA Center. Note that the repair conditions at each FA Center may differ.

## 4. Exclusion of loss in opportunity and secondary loss from warranty liability

Regardless of the gratis warranty term, Mitsubishi shall not be liable for compensation of damages caused by any cause found not to be the responsibility of Mitsubishi, loss in opportunity, lost profits incurred to the user by Failures of Mitsubishi products, special damages and secondary damages whether foreseeable or not, compensation for accidents, and compensation for damages to products other than Mitsubishi products, replacement by the user, maintenance of on-site equipment, start-up test run and other tasks.

## 5. Changes in product specifications

The specifications given in the catalogs, manuals or technical documents are subject to change without prior notice.

## 6. Product application

- (1) In using the Mitsubishi MELSEC programmable controller, the usage conditions shall be that the application will not lead to a major accident even if any problem or fault should occur in the programmable controller device, and that backup and fail-safe functions are systematically provided outside of the device for any problem or fault.
- (2) The Mitsubishi programmable controller has been designed and manufactured for applications in general industries, etc. Thus, applications in which the public could be affected such as in nuclear power plants and other power plants operated by respective power companies, and applications in which a special quality assurance system is required, such as for Railway companies or Public service purposes shall be excluded from the programmable controller applications.

In addition, applications in which human life or property that could be greatly affected, such as in aircraft, medical applications, incineration and fuel devices, manned transportation, equipment for recreation and amusement, and safety devices, shall also be excluded from the programmable controller range of applications.

However, in certain cases, some applications may be possible, providing the user consults their local Mitsubishi representative outlining the special requirements of the project, and providing that all parties concerned agree to the special circumstances, solely at the users discretion.

Ethernet is a trademark of Xerox Co., Ltd. in the United States.

Other company names and product names used in this document are trademarks or registered trademarks of respective owners.



**HEADQUARTERS**

**MITSUBISHI ELECTRIC EUROPE B.V. EUROPE**  
 German Branch  
 Gothaer Straße 8  
**D-40880 Ratingen**  
 Phone: +49 (0)2102 / 486-0  
 Fax: +49 (0)2102 / 486-1120

**MITSUBISHI ELECTRIC EUROPE B.V. FRANCE**  
 French Branch  
 25, Boulevard des Bouvets  
**F-92741 Nanterre Cedex**  
 Phone: +33 (0)1 / 55 68 55 68  
 Fax: +33 (0)1 / 55 68 57 57

**MITSUBISHI ELECTRIC EUROPE B.V. IRELAND**  
 Irish Branch  
 Westgate Business Park, Ballymount  
**IRL-Dublin 24**  
 Phone: +353 (0)1 4198800  
 Fax: +353 (0)1 4198890

**MITSUBISHI ELECTRIC EUROPE B.V. ITALY**  
 Italian Branch  
 Viale Colleoni 7  
**I-20041 Agrate Brianza (MI)**  
 Phone: +39 039 / 60 53 1  
 Fax: +39 039 / 60 53 312

**MITSUBISHI ELECTRIC CORPORATION JAPAN**  
 Office Tower "Z" 14 F  
**8-12, 1 chome, Harumi Chuo-Ku**  
 Tokyo 104-6212  
 Phone: +81 3 622 160 60  
 Fax: +81 3 622 160 75

**MITSUBISHI ELECTRIC EUROPE B.V. UK**  
 UK Branch  
 Travellers Lane  
**UK-Hatfield, Herts. AL10 8XB**  
 Phone: +44 (0)1707 / 27 61 00  
 Fax: +44 (0)1707 / 27 86 95

**MITSUBISHI ELECTRIC EUROPE B.V. SPAIN**  
 Spanish Branch  
 Carretera de Rubí 76-80  
**E-08190 Sant Cugat del Vallés (Barcelona)**  
 Phone: +34 93 / 565 3131  
 Fax: +34 93 / 589 1579

**MITSUBISHI ELECTRIC AUTOMATION USA**  
 500 Corporate Woods Parkway  
**Vernon Hills, IL 60061**  
 Phone: +1 847 478 21 00  
 Fax: +1 847 478 22 83

**EUROPEAN REPRESENTATIVES**

**GEVA AUSTRIA**  
 Wiener Straße 89  
**AT-2500 Baden**  
 Phone: +43 (0)2252 / 85 55 20  
 Fax: +43 (0)2252 / 488 60

**TEHNIKON BELARUS**  
 Oktyabrskaya 16/5, Off. 703-711  
**BY-220030 Minsk**  
 Phone: +375 (0)17 / 210 46 26  
 Fax: +375 (0)17 / 210 46 26

**Koning & Hartman B.V. BELGIUM**  
 Industrial Solutions  
 Woluwelaan 31  
**BE-1800 Vilvoorde**  
 Phone: +32 (0)2 / 257 02 40  
 Fax: +32 (0)2 / 257 02 49

**AKHNATON BULGARIA**  
 4 Andrej Ljapchev Blvd. Pb 21  
**BG-1756 Sofia**  
 Phone: +359 (0)2 / 97 44 05 8  
 Fax: +359 (0)2 / 97 44 06 1

**INEA CR d.o.o. CROATIA**  
 Losinjka 4 a  
**HR-10000 Zagreb**  
 Phone: +385 (0)1 / 36 940 -01/-02/-03  
 Fax: +385 (0)1 / 36 940 -03

**AutoCont Control Systems, s.r.o. CZECH REPUBLIC**  
 Jelinkova 59/3  
**CZ-721 00 Ostrava Svinov**  
 Phone: +420 (0)59 / 5691 150  
 Fax: +420 (0)59 / 5691 199

**AutoCont Control Systems, s.r.o. CZECH REPUBLIC**  
 Technologická 374/6  
**CZ-708 00 Ostrava-Pustkovec**  
 Phone: +420 595 691 150  
 Fax: +420 595 691 199

**B:TECH, a.s. CZECH REPUBLIC**  
 Na Ostrove 84  
**CZ-58001 Havlickuv Brod**  
 Phone: +420 (0)569 / 408 841  
 Fax: +420 (0)569 / 408 889

**B:TECH, a.s. CZECH REPUBLIC**  
 Headoffice  
 U Borové 69  
**CZ-580 01 Havlickuv Brod**  
 Phone: +420 569 777 777  
 Fax: +420 569 777 778

**Beijer Electronics A/S DENMARK**  
 Lautrupvej 1-3  
**DK-2750 Ballerup**  
 Phone: +45 (0)70 / 26 46 46  
 Fax: +45 (0)70 / 26 48 48

**Beijer Electronics Eesti OÜ ESTONIA**  
 Pärnu mnt.160i  
**EE-11317 Tallinn**  
 Phone: +372 (0)6 / 51 81 40  
 Fax: +372 (0)6 / 51 81 49

**Beijer Electronics OY FINLAND**  
 Jaakonkatu 2  
**FIN-01620 Vantaa**  
 Phone: +358 (0)207 / 463 500  
 Fax: +358 (0)207 / 463 501

**UTECO A.B.E.E. GREECE**  
 5, Mavrogenous Str.  
**GR-18542 Piraeus**  
 Phone: +30 211 / 1206 900  
 Fax: +30 211 / 1206 999

**Meltrade Ltd. HUNGARY**  
 Fertő utca 14.  
**HU-1107 Budapest**  
 Phone: +36 (0)1 / 431-9726  
 Fax: +36 (0)1 / 431-9727

**Beijer Electronics SIA LATVIA**  
 Vestienas iela 2  
**LV-1035 Riga**  
 Phone: +371 (0)784 / 2280  
 Fax: +371 (0)784 / 2281

**EUROPEAN REPRESENTATIVES**

**Beijer Electronics UAB LITHUANIA**  
 Savanoriu Pr. 187  
**LT-02300 Vilnius**  
 Phone: +370 (0)5 / 232 3101  
 Fax: +370 (0)5 / 232 2980

**INTEHSIS srl MOLDOVA**  
 bld. Traian 23/1  
**MD-2060 Kishinev**  
 Phone: +373 (0)22 / 66 4242  
 Fax: +373 (0)22 / 66 4280

**Koning & Hartman B.V. NETHERLANDS**  
 Haarlerbergweg 21-23  
**NL-1101 CH Amsterdam**  
 Phone: +31 (0)20 / 587 76 00  
 Fax: +31 (0)20 / 587 76 05

**Beijer Electronics AS NORWAY**  
 Postboks 487  
**NO-3002 Drammen**  
 Phone: +47 (0)32 / 24 30 00  
 Fax: +47 (0)32 / 84 85 77

**MPL Technology Sp. z o.o. POLAND**  
 Ul. Krakowska 50  
**PL-32-083 Balice**  
 Phone: +48 (0)12 / 630 47 00  
 Fax: +48 (0)12 / 630 47 01

**Sirius Trading & Services srl ROMANIA**  
 Aleea Lacul Morii Nr. 3  
**RO-060841 Bucuresti, Sector 6**  
 Phone: +40 (0)21 / 430 40 06  
 Fax: +40 (0)21 / 430 40 02

**CRAFT Consulting & Engineering d.o.o. SERBIA**  
 Bulevar Svetog Cara Konstantina 80-86  
**SER-18106 Nis**  
 Phone: +381 (0)18 / 292-24-4/5, 523 962  
 Fax: +381 (0)18 / 292-24-4/5, 523 962

**INEA SR d.o.o. SERBIA**  
 Karadjordjeva 12/260  
**SER-113000 Smederevo**  
 Phone: +381 (0)26 / 617 163  
 Fax: +381 (0)26 / 617 163

**CS MTrade Slovensko, s.r.o. SLOVAKIA**  
 Vajanskeho 58  
**SK-92101 Piestany**  
 Phone: +421 (0)33 / 7742 760  
 Fax: +421 (0)33 / 7735 144

**INEA d.o.o. SLOVENIA**  
 Stegne 11  
**SI-1000 Ljubljana**  
 Phone: +386 (0)1 / 513 8100  
 Fax: +386 (0)1 / 513 8170

**Beijer Electronics Automation AB SWEDEN**  
 Box 426  
**SE-20124 Malmö**  
 Phone: +46 (0)40 / 35 86 00  
 Fax: +46 (0)40 / 35 86 02

**ECONOTEC AG SWITZERLAND**  
 Hinterdorfstr. 12  
**CH-8309 Nürensdorf**  
 Phone: +41 (0)44 / 838 48 11  
 Fax: +41 (0)44 / 838 48 12

**GTS TURKEY**  
 Darulaceze Cad. No. 43 KAT. 2  
**TR-34384 Okmeydani-Istanbul**  
 Phone: +90 (0)212 / 320 1640  
 Fax: +90 (0)212 / 320 1649

**CSC Automation Ltd. UKRAINE**  
 15, M. Raskova St., Fl. 10, Office 1010  
**UA-02002 Kiev**  
 Phone: +380 (0)44 / 494 33 55  
 Fax: +380 (0)44 / 494-33-66

**EURASIAN REPRESENTATIVES**

**Kazpromautomatics Ltd. KAZAKHSTAN**  
 2, Scladskaya str.  
**KAZ-470046 Karaganda**  
 Phone: +7 3212 / 50 11 50  
 Fax: +7 3212 / 50 11 50

**ELEKTROSTILY RUSSIA**  
 Rubzovskaja nab. 4-3, No. 8  
**RU-105082 Moscow**  
 Phone: +7 495 / 545 3419  
 Fax: +7 495 / 545 3419

**ICOS RUSSIA**  
 Industrial Computer Systems ZAO  
 Ryazanskij Prospekt, 8A, Office 100  
**RU-109428 Moscow**  
 Phone: +7 495 / 232 0207  
 Fax: +7 495 / 232 0327

**NPP "URALEKTRA" RUSSIA**  
 Sverdlova 11A  
**RU-620027 Ekaterinburg**  
 Phone: +7 343 / 353 2745  
 Fax: +7 343 / 353 2461

**MIDDLE EAST REPRESENTATIVES**

**Ilan & Gavish Ltd. ISRAEL**  
 Automation Service  
 24 Shenkar St., Kiryat Arie  
**IL-49001 Petah-Tiqva**  
 Phone: +972 (0)3 / 922 18 24  
 Fax: +972 (0)3 / 924 0761

**Texel Electronics Ltd. ISRAEL**  
 2 Ha'umanut, P.O.B. 6272  
**IL-42160 Netanya**  
 Phone: +972 (0)9 / 863 08 91  
 Fax: +972 (0)9 / 885 24 30

**AFRICAN REPRESENTATIVE**

**CBI Ltd. SOUTH AFRICA**  
 Private Bag 2016  
**ZA-1600 Isando**  
 Phone: +27 (0)11 / 928 2000  
 Fax: +27 (0)11 / 392 2354